

# Balflex®



**CATÁLOGO DE  
CONEXIONES  
HIDRÁULICAS**

# Tecnología Europea

---

*Establecido desde 1963, **Balflex**<sup>®</sup> es un grupo europeo internacional de empresas que se ha especializado en el diseño, producción, montaje y distribución de todo tipo de productos altamente tecnológicos para la conducción de fluidos, medición de presión y transmisión de energía, brindando un extraordinario nivel de calidad.*

*6 décadas de conocimiento técnico y experiencia en este campo, convierten a **Balflex**<sup>®</sup> en la primera opción para las industrias minera, agrícola, de exploración marítima y construcción.*

*Hoy en día, el Grupo **Balflex**<sup>®</sup> cubre las necesidades de los usuarios de todo el mundo mediante sus propias plantas de producción, filiales y red de distribuidores certificados.*

*En **Balflex**<sup>®</sup> valoramos el significado interno de las palabras que usamos: **Excelencia** - la calidad de ser sobresalientes; **Innovación** - la acción o proceso de innovar; **Colaboración** - la relación de cooperación entre dos o más personas con un objetivo en común; **Tradición** - modo de pensar o actuar heredado de las generaciones anteriores.*

---





# Calidad

*La calidad es crucial para nosotros. Contamos con modernos equipos y laboratorios totalmente equipados, con el personal más experimentado de la industria.*

Balflex® ha obtenido diversas certificaciones por sus productos y sistemas de gestión. Este enfoque confiable y permanente nos ha permitido lograr nuestra certificación ISO 9001:2015. En Balflex® la calidad y atención siempre son una prioridad. Nos esmeramos en seguir desarrollando nuevos productos con un fuerte énfasis en la calidad.

## Miembro de:



## Certificado por:



## Tabla de Compatibilidad de Mangueras vs Férulas

Manguera vs férula		1/8"	3/16"	1/4"	5/16"	3/8"	1/2"	5/8"	3/4"	1"	1.1/4"	1.1/2"	2"	2.1/2"	3"
		- 02	- 03	- 04	- 05	- 06	- 08	- 10	- 12	- 16	- 20	- 24	- 32	- 40	- 48
Balflex®	Versiones	Balfit®	Balfit®	Balfit®	Balfit®	Balfit®	Balfit®	Balfit®	Balfit®	Balfit®	Balfit®	Balfit®	Balfit®	Balfit®	Balfit®
TEXMASTER 1			20.107	20.107	20.107	20.107	20.107	20.107	20.107	20.107					
TEXMASTER 2			20.107	20.107	20.107	20.107	20.107	20.107	20.107	20.107					
TEXMASTER 3				20.201	20.201	20.201	20.202	20.202	20.202	20.301	20.201	20.201	20.201		
FORZA UNO	SHARK SKIN TROPIC ARMOURGUARD		20.204 20.101	20.302 20.101	20.302 20.101	20.302 20.101	20.302 20.202	20.302 20.202	20.302 20.202	20.204 20.301	20.204 20.101	20.204 20.101	20.204 20.101	20.204	20.204
FORZA DUE	SHARK SKIN TROPIC ARMOURGUARD		20.204 20.201	20.302 20.201	20.302 20.201	20.302 20.201	20.302 20.202	20.302 20.202	20.302 20.202	20.204 20.302	20.204 20.201	20.204 20.201	20.204 20.201	20.204	20.204
BALPAC PREMIUM	SHARK SKIN TROPIC ARMOURGUARD			20.302	20.302	20.302	20.302	20.302	20.302	20.204					
IMPACTUS 5K	SHARK SKIN ARMOURGUARD			20.302	20.302	20.302	20.302	20.302	20.302	20.204					
IMPACTUS 6K	SHARK SKIN ARMOURGUARD			20.302	20.302	20.302	20.302	20.302	20.302	20.204					
BALPAC 3000	SHARK SKIN TROPIC ARMOURGUARD			20.305	20.305	20.305	20.305	20.302	20.302	20.204					
2-MAX				20.302		20.302	20.302								
3-MAX						20.200	20.200	20.200	20.200	20.200					
BALWASH 1W	SHARK SKIN			20.302 20.101	20.302 20.101	20.302 20.101	20.302 20.202								
BALWASH 2W	SHARK SKIN			20.302 20.201	20.302 20.201	20.302 20.201	20.302 20.202								
BALMASTER 4SP	ARMOURGUARD			20.200		20.200 20.NS4	20.200 20.NS4	20.200 20.NS4	20.200 20.NS4	20.200 20.NS4	20.200 20.NS4	20.200 20.NS4	20.200 20.NS4		
BALMASTER R12	ARMOURGUARD					20.NS4	20.NS4	20.NS4	20.NS4	20.NS4	20.NS4	20.NS4	20.NS4		



Manguera vs férrula		1/8"	3/16"	1/4"	5/16"	3/8"	1/2"	5/8"	3/4"	1"	1.1/4"	1.1/2"	2"	2.1/2"	3"
		- 02	- 03	- 04	- 05	- 06	- 08	- 10	- 12	- 16	- 20	- 24	- 32	- 40	- 48
Balflex®	Versiones	Balfit®	Balfit®	Balfit®	Balfit®	Balfit®	Balfit®	Balfit®	Balfit®	Balfit®	Balfit®	Balfit®	Balfit®	Balfit®	Balfit®
POWERSPIR 4SH	ARMOURGUARD									20.NS4 20.406	20.NS4 20.406	20.NS4 20.405	20.NS4 20.405	20.NS4 20.405	
POWERSPIR R13	ARMOURGUARD									20.NS4 20.406	20.NS4 20.406	20.406	20.406	20.406	
POWERSPIR R15	ARMOURGUARD									20.NS4 20.406	20.NS4 20.406	20.406	20.406	20.406	
BALFLON R14	NEGRA	20.107	20.107	20.107	20.107	20.107	20.107	20.107	20.107	20.107	20.107				
BALFLON CONVOLUTED	NEGRA			20.107	20.107	20.TFC	20.TFC	20.TFC	20.TFC	20.TFC	20.TFC	20.TFC	20.TFC	20.TFC	
ZETAFLEX	BITUBO NO CONDUCTIVA	20.107	20.107	20.107	20.107	20.107	20.107	20.107	20.107	20.107	20.107				
ZETAFLEX STEEL	BITUBO	20.107	20.107	20.107	20.107	20.107	20.107	20.107	20.107	20.107	20.107				
OMEGAFLEX PLUS	BITUBO NO CONDUCTIVA	20.107	20.107	20.107	20.107	20.107	20.107	20.107	20.107	20.107	20.107				

## Presiones Nominales de Conexiones de Manguera

En la siguiente tabla aparece la presión de trabajo máxima recomendada para cada tipo de conexión. Comuníquese con el fabricante cuando la información no esté disponible.

Conexiones en pulgadas (tamaño)													
Presión de trabajo máxima (MPa/psi) - factor de seguridad 4:1													
Descripción	Núm. de Pieza	-2	-3	-4	-5	-6	-8	-10	-12	-16	-20	-24	-32
NPTF Macho	XX.0400 XX.0410 XX.0490	34.5 5000		27.6 4000		20.7 3000	20.7 3000		17.2 2500	13.8 2000	7.9 1150	6.9 1000	6.9 1000
BSP Macho	XX.0100	42.0 6090		45.0 6525		40.0 5800	40.0 5800	40.0 5800	38.0 5510	34.5 5003	24.0 3480	21.0 3045	17.2 2494
BSP Swivel Hembra	XX.3012 XX.3042 XX.3092	42.0 6090		45.0 6525		40.0 5800	40.0 5800	40.0 5800	38.0 5510	34.5 5003	24.0 3480	21.0 3045	17.2 2494
BSP Swivel Hembra with O-ring	XX.3112 XX.3142 XX.3192			45.0 6525		40.0 5800	40.0 5800	40.0 5800	38.0 5510	34.5 5003	24.0 3480	21.0 3045	17.2 2494
JIC 37° Macho	XX.2000			35.0 5075	35.0 5075	35.0 5075	31.0 4495	24.0 3480	24.0 3480	21.0 3045	17.0 2465	14.0 2030	10.5 1523
JIC 37° Swivel Hembra	XX.4012 XX.4042 XX.4092 XX.4H12			35.0 5075	35.0 5075	35.0 5075	31.0 4495	24.0 3480	24.0 3480	21.0 3045	17.0 2465	14.0 2030	10.5 1523
Flange 3000 PSI	XX.7013 XX.7043 XX.7093						34.5 5000	34.5 5000	34.5 5000	34.5 5000	27.6 4000	20.7 3000	17.2 2500
Flange 6000 PSI	XX.7016 XX.7046 XX.7096						41.4 6000	41.4 6000		41.4 6000	41.4 6000	41.4 6000	41.4 6000
ORFS Macho	XX.4000			63.0 9135		63.0 9135	63.0 9135	40.0 5800	40.0 5800	40.0 5800	25.0 3625	25.0 3625	
ORFS Hembra	XX.4414 XX.4444 XX.4494 XX.44H4			63.0 9135		63.0 9135	63.0 9135	40.0 5800	40.0 5800	40.0 5800	25.0 3625	25.0 3625	

La Presión de trabajo del conjunto de manguera será inferior que las presiones dadas para sus tamaños en las normas de las conexiones y en la especificación relevante de la manguera.



<b>Hilo métrico (mm) – Serie ligera “L”</b>											
Presión de trabajo máxima (MPa/psi) – factor de seguridad 4:1											
Descripción	Núm. de Pieza	6	8	10	12	15	18	22	28	35	42
Metric Macho	XX.1000	25.0 3625	25.0 3625	25.0 3625	25.0 3625	25.0 3625	16.0 2320	16.0 2320	10.0 1450	10.0 1450	10.0 1450
Metric Swivel Hembra with O-ring	XX.5013 XX.5043 XX.5093	25.0 3625	25.0 3625	25.0 3625	25.0 3625	25.0 3625	16.0 2320	16.0 2320	10.0 1450	10.0 1450	10.0 1450

<b>Hilo métrico (mm) – Serie pesada “S”</b>											
Presión de trabajo máxima (MPa/psi) – factor de seguridad 4:1											
Descripción	Núm. de Pieza	6	8	10	12	14	16	20	25	30	38
Metric Macho	XX.1100	63.0 9135	63.0 9135	63.0 9135	63.0 9135	63.0 9135	40.0 5800	40.0 5800	40.0 5800	25.0 3625	25.0 3625
Metric Swivel Hembra with O-ring	XX.5113 XX.5143 XX.5193	63.0 9135	63.0 9135	63.0 9135	63.0 9135	63.0 9135	40.0 5800	40.0 5800	40.0 5800	25.0 3625	25.0 3625

La Presión de trabajo del conjunto de manguera será inferior que las presiones dadas para sus tamaños en las normas de las conexiones y en la especificación relevante de la manguera.

Gracias a nuestro proceso de galvanizado libre de Cr-VI con revestimiento de zinc denso, se obtiene una alta resistencia a la corrosión en todos nuestros productos de acero al carbono, en conformidad con las normativas de la Unión Europea y EE.UU., así como con todos los estándares de conexiones pertinentes, tales como SAE J516 y DIN EN ISO 12151.

Debido a la exclusión de cromo hexavalente, garantizamos un producto final ecológico, sin comprometer la resistencia a la corrosión.

Cuando nuestro proceso de galvanizado se somete a pruebas conforme a EN ISO 9227, garantiza un mínimo de 240 horas antes de que aparezca corrosión. (Los valores incluidos se miden antes de la operación de prensado)

## Método Correcto para Instalar Terminales Hembra Giratorias

Para garantizar un sellado hermético entre los terminales hembras giratorias de la manguera incluidos en este catálogo y los respectivos adaptadores es necesario seguir el procedimiento que se indica a continuación, el cual es diferente del montaje de tubo hidráulico (estas instrucciones no son válidas para conexiones ORFS).

### Sello metal-metal

Apriete la tuerca a mano y luego utilice una llave para girarla sólo 1/4 de vuelta.

### Sello blando con O'ring

Apriete la tuerca a mano y luego utilice una llave para girarla sólo 1/4 de vuelta.

En todos los casos, cerciórese de que la manguera esté correctamente alineada antes de apretar la tuerca en el adaptador correspondiente.



## Valores de Par de Torque

Hembra giratoria métrica			
Rosca Métrica	D.E. Tubo	Nm	
		nominal	min. - max.
M 12x1,5	06L	16	15 - 17
M 14x1,5	08L	16	15 - 17
M 16x1,5	10L	26	25 - 28
M 18x1,5	12L	37	35 - 39
M 22x1,5	15L	47	45 - 50
M 26x1,5	18L	89	85 - 94
M 30x2	22L	116	110 - 121
M 36x2	28L	137	130 - 143
M 45x2	35L	226	215 - 237
M 52x2	42L	347	330 - 363
M 14x1,5	06S	26	25 - 28
M 16x1,5	08S	42	40 - 44
M 18x1,5	10S	53	50 - 55
M 20x1,5	12S	63	60 - 66
M 22x1,2	14S	79	75 - 83
M 24x1,5	16S	84	80 - 88
M 30x2	20S	126	120 - 132
M 36x2	25S	179	170 - 187
M 42x2	30S	263	250 - 275
M 52x2	38S	368	350 - 385

Hembra giratoria métrica BSP			
Hilo BSPP	Tamaño	Nm	
		estilo A	estilo B
G1/8	-2	-	10
G1/4	-4	20	20
G3/8	-6	35	35
G1/2	-8	50	60
G5/8	-10	60	70
G3/4	-12	85	115
G1	-16	115	140
G1.1/4	-20	190	210
G1.1/2	-24	240	290
G2	-32	300	400



Hembra giratoria JIC 37°		
 Rosca UNF	Tamaño	 Nm +10% -0%
7/16-20	-4	15
1/2-20	-5	19
9/16-18	-6	24
3/4-16	-8	49
7/8-14	-10	77
1.1/16-12	-12	107
1.5/16-12	-16	147
1.5/8-12	-20	172
1.7/8-12	-24	215
2.1/2-12	-32	332

Hembra giratoria ORFS		
 Rosca UNF	Tamaño	 Nm +10% -0%
9/16-18	-4	25
11/16-18	-6	40
13/16-16	-8	55
1-14	-10	60
1.3/16-12	-12	90
1.5/16-12	-14	115
1.7/16-12	-16	125
1.11/16-12	-20	170
2-12	-24	200

Los valores de par de torque para otros materiales son los siguientes:

- **Adaptadores y conexiones de latón**  
65% del valor de torque para acero.
- **Acero inoxidable**  
Use el margen alto de torque para el acero.  
Se deben lubricar los hilos para estos materiales.
- **Metales diferentes**  
Use el valor de torque designado para el más bajo de los dos materiales.
- **Todos los hilos de las conexiones deben estar sin lubricación.**

#### Nota

Los valores que aparecen en las tablas son los típicos para lograr los métodos de montaje recomendados cuando el material de la conexión es de acero zincado. Para otros materiales deberán usarse valores diferentes.

## Identificación rápida de conectores hidráulicos

### DIN 24° serie ligera (L) y serie pesada (S) con O'ring

El conector macho tiene un asiento cónico con un ángulo de sellado de 24° con hilo métricos rectos. El conector hembra tiene un cono convexo de 24° con O' ring y una tuerca giratoria con hilo métricos rectos.

Norma: ISO 12151-2, ISO 8434-1, ISO 8434-4

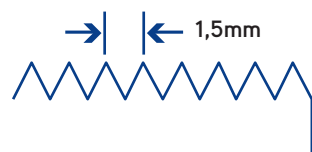
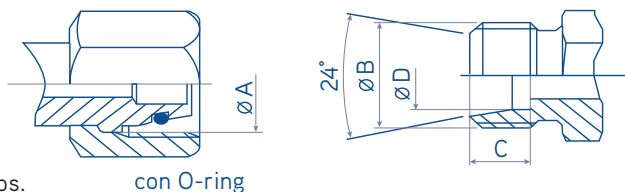

#### Hilo Métrico

Se define por el diámetro externo y la separación (distancia entre 2 crestas del hilo) ejemplo: M22x1.5 - separación de 1.5mm.

D.E. Tubo (mm)	Tipo de tubo	Hilo métrica	ØA (mm)	ØB (mm)	C (mm)	ØD (mm)
6.00	6L	M12x1.5	10.50	12.00	7.00	6.20
6.00	6S	M14x1.5	12.50	14.00	7.00	6.20
8.00	8L	M14x1.5	12.50	14.00	7.00	8.20
8.00	8S	M16x1.5	14.50	16.00	7.00	8.20
10.0	10L	M16x1.5	14.50	16.00	7.00	0.20
10.0	10S	M18x1.5	16.50	18.00	7.50	0.20
12.0	12L	M18x1.5	16.50	18.00	7.00	2.20
12.0	12S	M20x1.5	18.50	20.00	7.50	2.20
14.0	14S	M22x1.5	20.50	22.00	8.00	14.20
15.0	15L	M22x1.5	20.50	22.00	7.00	15.20
16.0	16S	M24x1.5	22.5	24.0	8.5	16.20
18.0	18L	M26x1.5	24.5	26.0	7.50	18.20
20.0	20S	M30x2.0	27.9	30.0	10.50	20.20
22.0	22L	M30x2.0	27.9	30.0	7.50	22.20
25.0	25S	M36x2.0	33.9	36.0	12.00	25.20
28.0	28L	M36x2.0	33.9	36.0	7.50	28.20
30.0	30S	M42x2.0	39.9	42.0	13.50	30.20
35.0	35L	M45x2.0	42.9	45.0	10.50	35.30
38.0	38S	M52x2.0	49.9	52.0	16.00	38.30
42.0	42L	M52x2.0	49.9	52.0	11.00	42.30



## Hilo Paralelo Británico (BSPP)

También denominadas hilos Whitworth, las conexiones con hilo BSP se sellan usando superficies angulares metal con metal o una combinación de metal con metal y un O' ring. El ángulo de las superficies de sellado es 60° para ambas formas. Norma: BS 5200 ISO 12151-6

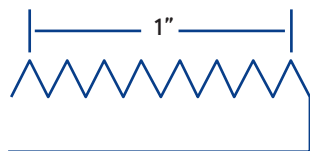
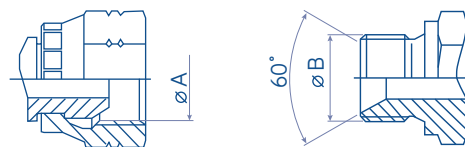

### Hilo BSP

La identificación se realiza midiendo el diámetro externo del hilo y el número de crestas por pulgada (25.4mm).

D.I. Tubo (mm)	D.E. Tubo (mm)	Tamaño	Hilo BSP	ØA (mm)	ØB (mm)
6	10	- 2	1/8" -28	8.60	9.70
8	13	- 4	1/4" -19	11.50	13.20
12	17	- 6	3/8" -19	14.90	16.70
15	21	- 8	1/2" -14	18.60	20.90
18	23	- 10	5/8" -14	20.60	22.90
20	27	- 12	3/4" -14	24.10	26.40
26	34	- 16	1" -11	30.3	33.20
33	42	- 20	1.1/4" -11	38.90	41.90
40	49	- 24	1.1/2" -11	44.90	47.80
50	60	- 32	2" -11	56.70	59.60

## Hilo Cónico Británico (BSPT)

Las conexiones se sellan mediante el mecanismo de interconexión del hilo. Se debe tener cuidado de no confundir el conecion BSPT con el conecion macho NPTF. El conector BSPT tiene un ángulo de hilo de 55°.

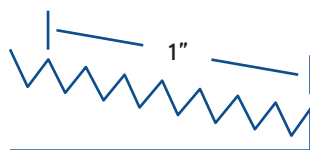
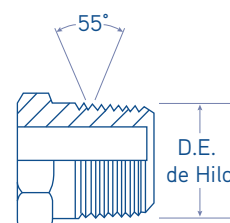

### Hilo BSPT

La identificación se realiza midiendo el diámetro externo del hilo y el número de crestas por pulgada (25.4mm).

D.I. Tubo (mm)	D.E. Tubo (mm)	Tamaño	Hilo BSPT	ØA (mm)
5	10	- 2	1/8" -28	9.73
8	13	- 4	1/4" -19	13.16
12	17	- 6	3/8" -19	16.66
15	21	- 8	1/2" -14	20.96
20	27	- 12	3/4" -14	26.44
26	34	- 16	1" -11	33.25
33	42	- 20	1.1/4" -11	41.91
40	49	- 24	1.1/2" -11	47.80
50	60	- 32	2" -11	59.61
50	60	- 32	2" -11	56.70

## BSP Sello Plano

Estas conexiones poseen hilos paralelos BSP, pero la superficie de sellado es plana. La unión se realiza cuando el sello compuesto se comprime contra la cara plana hembra.

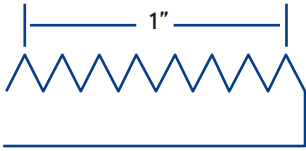
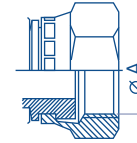

### Hilo BSP (Plano)

La identificación se realiza midiendo el diámetro externo del hilo y el número de crestas por pulgada (25.4mm).

D.E. Tubo (mm)	D.E. Tubo (mm)	Tamaño	Hilo BSPT	ØA (mm)
6	10	- 2	1/8" -28	8.60
8	13	- 4	1/4" -19	11.50
12	17	- 6	3/8" -19	14.90
15	21	- 8	1/2" -14	18.60
18	23	- 12	5/8" -14	20.60
20	27	- 16	3/4" -14	24.10
26	34	- 20	1" -11	30.30
33	42	- 20	1.1/4" -11	38.90
40	49	- 24	1.1/2" -11	44.90
50	60	- 32	2" -11	56.70

## Hilo Cónico Americano (NPTF)

Este tipo de conexión utiliza la interconexión entre la rosca para efectuar el sellado y, como tal, posee un hilo cónico que se deforma y crea la unión. Tiene superficies angulares de sellado de 30°, formando un asiento de 60° invertido (cóncavo). Norma: SAE J476 / ANSI/ASME B1.20.1

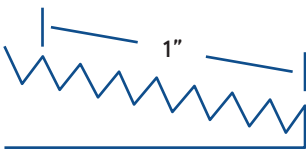
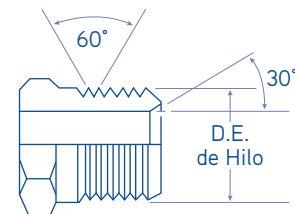

### Hilo NPT

La identificación se realiza midiendo el diámetro externo del hilo y el número de crestas por pulgada (25.4mm).

Tamaño	Hilo NPTF	ØA (mm)
- 2	1/8" -27	10.24
- 4	1/4" -18	13.61
- 6	3/8" -18	17.05
- 8	1/2" -14	21.22
- 12	3/4" -14	26.56
- 16	1" -11.5	33.22
- 20	1.1/4" -11.5	41.98
- 24	1.1/2" -11.5	48.05
- 32	2" -11.5	60.09



## SAE JIC 37°

Comúnmente denominados terminales JIC, estas conexiones con tipo de sellado metal con metal tienen un abocinado de 37° (ángulo de superficie de sellado) e hilos finos UNF rectas. La especificación de diseño original para los B conexiones proviene de la "Society of Automotive Engineers" (SAE).

Norma: ISO 12151-5, ISO 8434-2, SAE J516

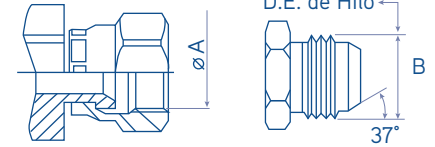

D.E. tubo (pulgadas)	Tamaño	Hilo UNF	ØA (mm)	ØB (mm)
1/4"	- 4	7/16" -20	10.00	11.10
5/16"	- 5	1/2" -20	11.60	12.70
3/8"	- 6	9/16" -18	13.00	14.30
1/2"	- 8	3/4" -16	17.60	19.10
5/8"	- 10	7/8" -14	20.50	22.20
3/4"	- 12	1.1/16" -12	24.60	27.00
7/8"	- 14	1.3/16" -12	28.30	30.10
1"	- 16	1.5/16" -12	31.30	33.30
1.1/4"	- 20	1.5/8" -12	39.20	41.30
1.1/2"	- 24	1.7/8" -12	45.60	47.60
2"	- 32	2.1/2" -12	61.50	63.50

## Sello de cara plana con O'ring (ORFS)

Este tipo de conexiones poseen un alto nivel de sellado y una buena resistencia a la vibración. Las conexiones usan el mecanismo de compresión del O' ring para realizar el sellado. Las conexiones hembra poseen caras planas y tuercas giratorias con hilos UNF rectos. En las conexiones macho el O' ring se sitúa en una ranura de la cara plana. Norma: ISO 12151-1, ISO 8434-3, SAE J516

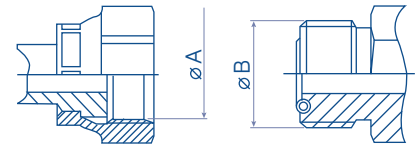

D.E. tubo (pulgadas)	Tamaño	Hilo UNF	ØA (mm)	ØB (mm)
1/4"	- 4	9/16" -18	13.00	14.20
3/8"	- 6	11/16" -16	15.90	17.50
1/2"	- 8	13/16" -16	19.10	20.60
5/8"	- 10	1" -14	23.80	25.40
3/4"	- 12	1.3/16" -12	28.20	30.10
1"	- 16	1.7/16" -12	34.15	36.50
1.1/4"	- 20	1.11/16" -12	40.50	42.90
1.1/2"	- 24	2" -12	48.80	50.80

## Flange cód.61 (3000 PSI), cód.62 (6000 PSI)

El mecanismo de sellado se realiza mediante compresión del O' ring en la cara de la cabeza del flange contra la superficie de la conexión del puerto. Las conexiones de flange generalmente se dividen en dos clases de presión: 21.0 MPa/ 3000 psi (SFL) o 42.0 MPa/ 6000 psi (SFS). Además de estas flanges, también es posible encontrar en el mercado flanges Komatsu y CATERPILLAR específicas para clientes. Norma: ISO 6162-1,ISO 6162-2

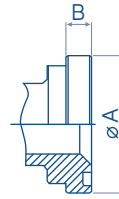

Flange (pulg.)	Tamaño	3000 psi			6000 psi			SuperCat		
		ØA (mm)	B (mm)	O-ring (mm)	ØA (mm)	B (mm)	O-ring (mm)	ØA (mm)	B (mm)	O-ring (mm)
1/2"	- 8	30.18	6.73	18.64x3.53	31.75	7.75	18.64x3.53	31.75	14.22	18.64x3.53
5/8"*	- 10	34.25	6.00	21.70x3.53						
3/4"	- 12	38.10	6.73	24.99x3.53	41.28	8.76	24.99x3.53	41.28	14.22	24.99x3.53
1"	- 16	44.45	8.00	32.92x3.53	47.63	9.53	32.92x3.53	47.63	14.22	32.92x3.53
1.1/4"	- 20	50.80	8.00	37.69x3.53	53.98	10.29	37.69x3.53	53.98	14.22	37.69x3.53
1.1/2"	- 24	60.33	8.00	47.22x3.53	63.50	12.57	47.22x3.53	63.50	14.22	47.22x3.53
2"	- 32	71.42	9.53	56.74x3.53	79.38	12.57	56.74x3.53	79.38	14.22	56.74x3.53
2.1/2"	- 40	84.12	9.53	69.44x3.53						
3"	- 48	101.60	9.53	85.32x3.53						

\* Si bien no forma parte de la norma SAE o ISO, el cabezal del flange tamaño -10 (5/8) está ganando popularidad. Este flange suele encontrarse en equipos Komatsu o en accionamientos hidrostáticos de maquinaria agrícola.

## Norma Industrial Japonesa (JIS)

La norma industrial japonesa (JIS) utiliza un asiento angular de sellado de 30° y hilos BSP paralelas.

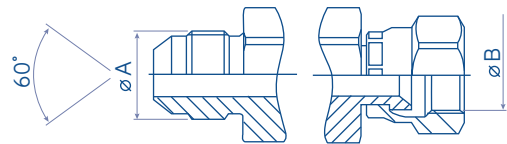

## Hilo Komatsu (FMK)

Utiliza un asiento angular de sellado de 30° con hilo métrico.

Rosca métrica	ØA (mm)	ØB (mm)	Hilo BSP	ØA (mm)	ØB (mm)
M14X1.5	12.50	14.00	1/4" -19	11.50	13.20
M18X1.5	16.50	18.00	3/8" -19	14.90	16.70
M16X1.5	14.50	16.00	1/2" -14	18.60	20.90
M18X1.5	16.50	18.00	3/4" -14	24.10	26.40
M22X1.5	20.50	22.00	1" -11	30.30	33.20
M24X1.5	22.50	24.00			
M30X1.5	28.50	30.00			
M33X2.0	31.00	33.00			
M42X2.0	40.00	42.00			



# Férrulas

---



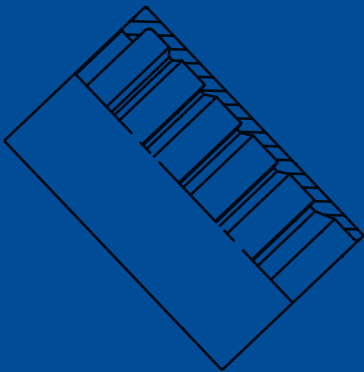
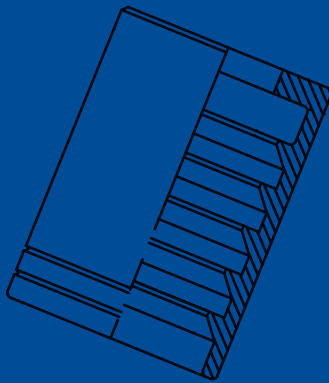
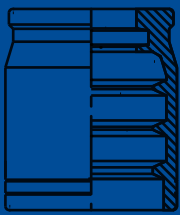
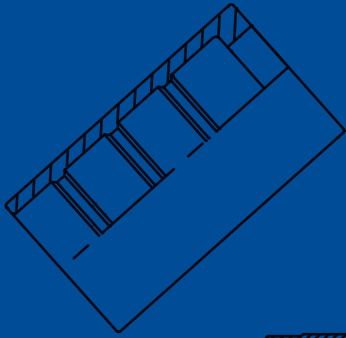
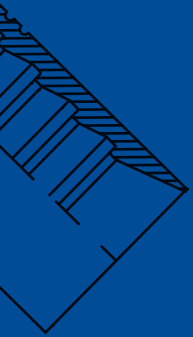

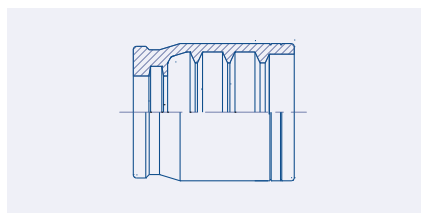

**Férrula NO PELAR Balfit®  
para 1 y 2 Mallas**

20.204 / 20.302

pág. 19

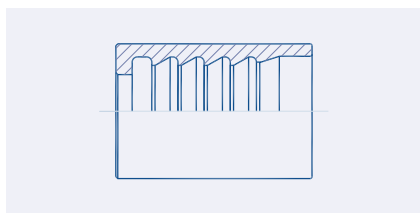

**Férrula NO PELAR Balfit®  
para 1 Malla**

20.101 / 20.301

pág. 20

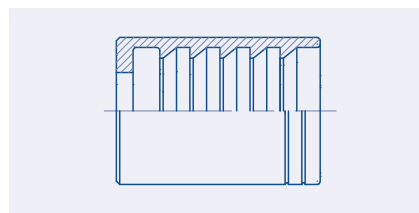

**Férrula NO PELAR Balfit®  
para 2 Mallas**

20.201 / 20.302

pág. 20

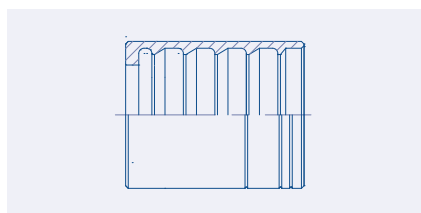

**Férrula NO PELAR Balfit®  
para 1 y 2 Mallas**

20.202

pág. 21

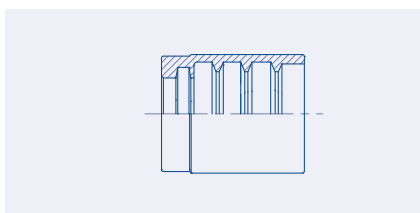

**Férrula NO PELAR Balfit®  
para 1 Malla**

20.305

pág. 21

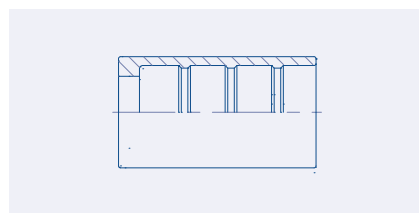

**Férrula NO PELAR Balfit® para  
PTFE, Termoplástico y Malla Textil**

20.107

pág. 22

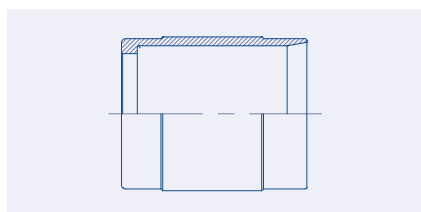

**Férrula NO PELAR Balfit®  
para Corrugada de PTFE**

20.TFC

pág. 23

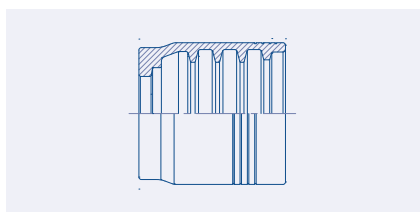

**Férrula NO PELAR Balfit®  
para 4 Espirales**

20.NS4

pág. 23

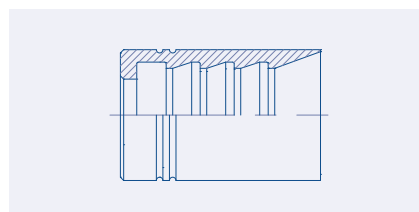

**Férrula PELAR EXTERIOR  
Balfit® para 2 Mallas y 4  
Espirales**

20.200

pág. 24

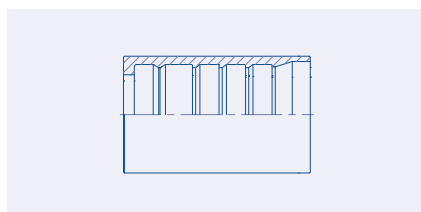

**Férrula PELAR DOBLE Balfit®  
para 4 Espirales**

20.405

pág. 24

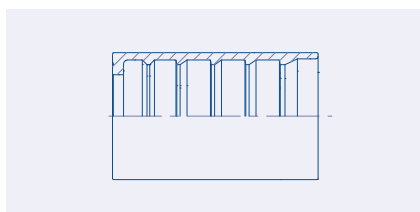

**Férrula PELAR DOBLE Balfit®  
para 4 y 6 Espirales**

20.406

pág. 25



# Férrula NO PELAR Balfit® para 1 y 2 Mallas

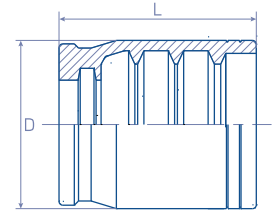

20.204. / 20.302.

REFERENCIA	manguera	manguera Ø		dimensiones (mm)	
	tabla medidas	mm	pulg.	L	D
20.204.03	- 3	4,8	3/16"	26.0	21.0
20.302.04	- 4	6,3	1/4"	25.8	22.0
20.302.05	- 5	8,0	5/16"	27.4	24.0
20.302.06	- 6	9,5	3/8"	30.0	26.0
20.302.08	- 8	12,7	1/2"	32.5	30.0
20.302.10	- 10	16,0	5/8"	35.0	34.0
20.302.12	- 12	19,0	3/4"	40.0	38.0
20.204.16	- 16	25,4	1"	47.6	46.3
20.204.20	- 20	32,0	1-1/4"	55.0	58.0
20.204.24	- 24	38,0	1-1/2"	60.3	65.0
20.204.32	- 32	50,8	2"	62.7	78.0
20.204.40	- 40	63,0	2-1/2"	72.2	95.0
20.204.48	- 48	76,0	3"	80.0	110.0

**MATERIAL:** Acero al carbono

**ACABADO:** Enchapado sin cromo-(VI)  
/ conforme a ROHS

**VERSIONES:** acero inoxidable  
AISI 316

## Apta para usar en mangueras con malla de mediana y alta presión:

FORZA UNO; FORZA UNO "SHARK SKIN"; FORZA UNO "TROPIC"; FORZA DUE; FORZA DUE "SHARK SKIN"; FORZA DUE "TROPIC"; BALPAC PREMIUM; BALPAC PREMIUM "SHARK SKIN"; IMPACTUS 5K; IMPACTUS 6K; BALPAC 3000; BALPAC 3000 "SHARK SKIN"; 2-MAX JACK; BALWASH 1W; BALWASH 2W

## Férrula NO PELAR Balfit® para 1 Malla

20.101. / 20.301.

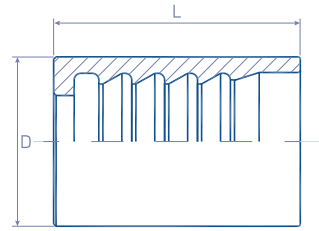

REFERENCIA	manguera tabla medidas	manguera Ø		dimensiones (mm)	
		mm	pulg.	L	D
20.101.03	- 3	4,8	3/16"	26.0	19.0
20.101.04	- 4	6,3	1/4"	29.0	19,8
20.101.05	- 5	8,0	5/16"	30.0	22.0
20.101.06	- 6	9,5	3/8"	31.6	24.0
20.301.16	- 16	25,4	1"	50.0	45.0
20.101.20	- 20	32,0	1.1/4"	60.0	53.0
20.101.24	- 24	38,0	1.1/2"	73.0	58.0
20.101.32	- 32	50,8	2"	77.0	73.0

**MATERIAL:** Acero al carbono

**ACABADO:** Enchapado sin cromo-(VI)  
/ conforme a ROHS

**VERSIONES:** acero inoxidable  
AISI 316

**Apta para usar en mangueras con malla de mediana y alta presión:**

FORZA UNO; FORZA UNO "SHARK SKIN"; FORZA UNO "TROPIC"; BALWASH 1W

## Férrula NO PELAR Balfit® para 2 Mallas

20.201. / 20.302.

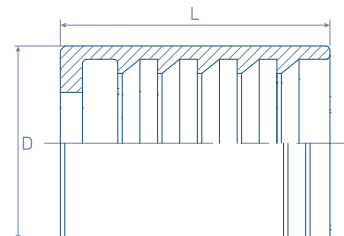

REFERENCIA	manguera tabla medidas	manguera Ø		dimensiones (mm)	
		mm	pulg.	L	D
20.201.04	- 4	6,3	1/4"	30.5	22.0
20.201.05	- 5	8,0	5/16"	30.5	21.0
20.201.06	- 6	9,5	3/8"	32.0	25.0
20.302.16	- 16	25,4	1"	50.0	48.0
20.201.20	- 20	32,0	1.1/4"	59.0	56.0
20.201.24	- 24	38,0	1.1/2"	70.0	65.0
20.201.32	- 32	50,8	2"	77.0	75.3

**MATERIAL:** Acero al carbono

**ACABADO:** Enchapado sin cromo-(VI)  
/ conforme a ROHS

**VERSIONES:** acero inoxidable  
AISI 316

**Apta para usar en mangueras con malla de mediana y alta presión:**

FORZA DUE; FORZA DUE "SHARK SKIN"; FORZA DUE "TROPIC"; TEXMASTER 3; BALWASH 2W;  
IMPACTUS 5K; IMPACTUS 6K;



# Férrula NO PELAR Balfit® para 1 y 2 Mallas

20.202.

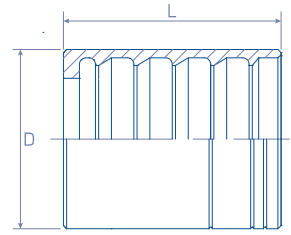

REFERENCIA	manguera		manguera Ø		dimensiones (mm)	
	tabla medidas		mm	pulg.	L	D
20.202.08	- 8		12,7	1/2"	34.0	28.0
20.202.10	- 10		16,0	5/8"	37.0	32.0
20.202.12	- 12		19,0	3/4"	42.50	36.0

**MATERIAL:** Acero al carbono

**ACABADO:** Enchapado sin cromo-(VI)  
/ conforme a ROHS

**VERSIONES:** acero inoxidable  
AISI 316

**Apta para usar en mangueras con malla de mediana y alta presión:**

FORZA UNO; FORZA UNO "SHARK SKIN"; FORZA UNO "TROPIC"; FORZA DUE; FORZA DUE "SHARK SKIN"; FORZA DUE "TROPIC"; TEXMASTER 3; BALWASH 1W; BALWASH 2W

# Férrula NO PELAR Balfit® para 1 Malla

20.305.

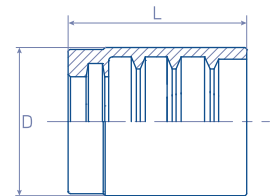

REFERENCIA	manguera		manguera Ø		dimensiones (mm)	
	tabla medidas		mm	pulg.	L	D
20.305.04	- 4		6,3	1/4"	22.9	19.0
20.305.05	- 5		8,0	5/16"	27.6	20.0
20.305.06	- 6		9,5	3/8"	30.2	23.0
20.305.08	- 8		12,7	1/2"	32.0	26.5
20.305.10	- 10		16,0	5/8"	35.0	29.0
20.305.12	- 12		19,0	3/4"	40.8	33.0
20.305.16	- 16		25,4	1"	45.0	41.9

**MATERIAL:** Acero al carbono

**ACABADO:** Enchapado sin cromo-(VI)  
/ conforme a ROHS

**VERSIONES:** acero inoxidable  
AISI 316

**Apta para usar en mangueras con malla de mediana y alta presión:**

BALPAC 3000; BALPAC 3000 "SHARK SKIN"

# Férrula NO PELAR Balfit® para PTFE, Termoplástico y Malla Textil

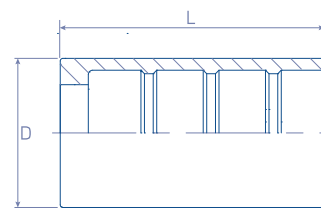

20.107.

REFERENCIA	manguera	manguera Ø		dimensiones (mm)	
	tabla medidas	mm	pulg.	L	D
20.107.02	- 2	3,2	1/8"	24,1	13,0
20.107.03	- 3	4,8	3/16"	25,0	15,0
20.107.04	- 4	6,3	1/4"	29,2	17,0
20.107.05	- 5	8,0	5/16"	31,0	18,0
20.107.06	- 6	9,5	3/8"	31,0	21,0
20.107.08	- 8	12,7	1/2"	34,0	25,3
20.107.10	- 10	16,0	5/8"	37,0	29,0
20.107.12	- 12	19,0	3/4"	43,0	32,0
20.107.16	- 16	25,4	1"	50,5	40,0

**MATERIAL:** Acero al carbono

**ACABADO:** Enchapado sin cromo-(VI) / conforme a ROHS

**VERSIONES:** acero inoxidable AISI 316

## Apta para usar en mangueras de PTFE, termoplásticas y de malla textil:

TEXMASTER 1, TEXMASTER 2; BALFLON SAE 100R14; BALFLON CONVOLUTED; BALFLON CONVOLUTED BLACK CONDUCTIVE; ZETAFLX; ZETAFLX TWIN; ZETAFLX NON CONDUCTIVE; ZETAFLX NON CONDUCTIVE TWIN; ZETAFLX STEEL; ZETAFLX STEEL TWIN; OMEGAFLEX PLUS; OMEGAFLEX PLUS TWIN LINE; OMEGAFLEX PLUS NON CONDUCTIVE; OMEGAFLEX PLUS TWIN NON CONDUCTIVE; ZETAFLX 3000; ZETAFLX 3000 TWIN; ZETAFLX 3000 NON CONDUCTIVE; ZETAFLX 3000 TWIN NON CONDUCTIVE; PAINTSPRAY



# Férrula NO PELAR Balfit® para Corrugada de PTFE

20.TFC.

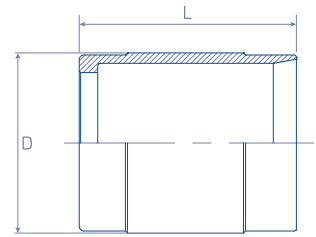

REFERENCIA	manguera		manguera Ø		dimensiones (mm)	
	tabla medidas		mm	pulg.	L	D
20.TFC.08	- 8		12,7	1/2"	32.0	23.5
20.TFC.12	- 12		19,0	3/4"	43.0	32.0
20.TFC.16	- 16		25,4	1"	47.0	38.1
20.TFC.20	- 20		32,0	1-1/4"	59.0	46.0
20.TFC.24	- 24		38,0	1-1/2"	63.0	55.0
20.TFC.32	- 32		50,8	2"	70.0	69.0

**MATERIAL:** Acero al carbono

**ACABADO:** Enchapado sin cromo-(VI)  
/ conforme a ROHS

**VERSIONES:** acero inoxidable  
AISI 316

**Apta para usar en mangueras de PTFE:**

BALFLON CONVOLUTED; BALFLON CONVOLUTED BLACK CONDUCTIVE

# Férrula NO PELAR Balfit® para 4 Espirales

20.NS4.

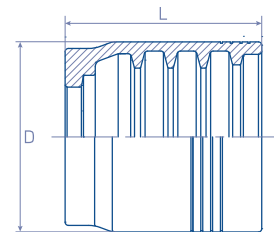

REFERENCIA	manguera		manguera Ø		dimensiones (mm)	
	tabla medidas		mm	pulg.	L	D
20.NS4.06	- 6		9,5	3/8"	30.0	29.0
20.NS4.08	- 8		12,7	1/2"	33.5	33.0
20.NS4.10	- 10		16,0	5/8"	35.5	37.0
20.NS4.12	- 12		19,0	3/4"	40.0	42.0
20.NS4.16	- 16		25,4	1"	54.0	48.9
20.NS4.20	- 20		32,0	1-1/4"	61.0	61.0
20.NS4.24	- 24		38,0	1-1/2"	71.0	70.0
20.NS4.32	- 32		50,8	2"	88.0	84.8

**MATERIAL:** Acero al carbono

**ACABADO:** Enchapado sin cromo-(VI)  
/ conforme a ROHS

**VERSIONES:** acero inoxidable  
AISI 316

**Apta para usar en mangueras de alta presión con 4 espirales:**

BALMASTER BESTFLEX 4SP; POWERSPIR BESTFLEX 4SH; BALMASTER BESTFLEX R12  
POWERSPIR BESTFLEX R13 (DN20 -3/4" & DN25 - 1"); POWERSPIR BESTFLEX R15  
(DN20 -3/4" & DN25 - 1")

# Férrula PELAR EXTERIOR Balfit® para 2 Mallas y 4 Espirales

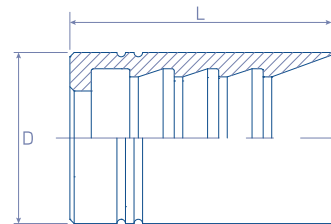

20.200.

REFERENCIA	manguera	manguera Ø		dimensiones (mm)	
	tabla medidas	mm	pulg.	L	D
20.200.04	- 4	6,3	1/4"	20.0	30.6
20.200.05	- 5	8,0	5/16"	24.0	30.0
20.200.06	- 6	9,5	3/8"	25.0	32.0
20.200.08	- 8	12,7	1/2"	30.0	34.0
20.200.10	- 10	16,0	5/8"	34.0	37.0
20.200.12	- 12	19,0	3/4"	38.0	43.0
20.200.16	- 16	25,4	1"	36.4	50.0
20.200.20	- 20	32,0	1.1/4"	56.0	59.0
20.200.24	- 24	38,0	1.1/2"	62.0	63.1
20.200.32	- 32	50,8	2"	75.1	78.0

**MATERIAL:** Acero al carbono

**ACABADO:** Enchapado sin cromo-(VI)  
/ conforme a ROHS

**VERSIONES:** acero inoxidable  
AISI 316

**Apta para usar en mangueras de mediana y alta presión con malla y 4 espirales:**

FORZA DUE; FORZA DUE "SHARK SKIN"; FORZA DUE "TROPIC; BALMASTER BESTFLEX 4SP;  
2-MAX; 3-MAX; BALWASH 1W; BALWASH 2W

# Férrula PELAR DOBLE Interlock Balfit® para 4 Espirales

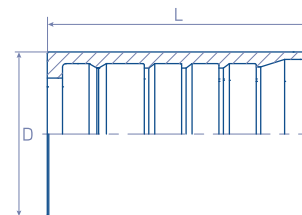

20.405.

REFERENCIA	manguera	manguera Ø		dimensiones (mm)	
	tabla medidas	mm	pulg.	L	D
20.405.20	- 20	31,8	1.1/4"	88.0	55.0
20.405.24	- 24	38,1	1.1/2"	94.0	62.0
20.405.32	- 32	50,8	2"	99.0	78.0

**MATERIAL:** Acero al carbono

**ACABADO:** Enchapado sin cromo-(VI)  
/ conforme a ROHS

**VERSIONES:** acero inoxidable  
AISI 316

**Apta para usar en mangueras de alta presión con 4 espirales:**

POWERSPIR BESTFLEX 4SH



# Férrula PELAR DOBLE Interlock Balfit® para 4 y 6 Espirales

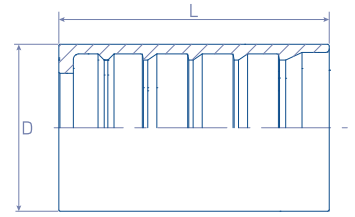

20.406.

REFERENCIA	manguera	manguera Ø		dimensiones (mm)	
	tabla medidas	mm	pulg.	L	D
20.406.12	- 12	19,1	3/4"	60.0	38.0
20.406.16	- 16	25,4	1"	74.5	46.0
20.406.20	- 20	31,8	1.1/4"	88.0	60.0
20.406.24	- 24	38,1	1.1/2"	94.0	67.0
20.406.32	- 32	50,8	2"	99.0	84.4

**MATERIAL:** Acero al carbono

**ACABADO:** Enchapado sin cromo-(VI)  
/ conforme a ROHS

**VERSIONES:** acero inoxidable  
AISI 316

**Apta para usar en mangueras de alta presión con 4 y 6 espirales:**

POWERSPIR BESTFLEX 4SH (DN20 -3/4" & DN25 - 1"); POWERSPIR BESTFLEX R13;  
POWERSPIR BESTFLEX R15

# Conexiones Hidráulicas Estándar

---

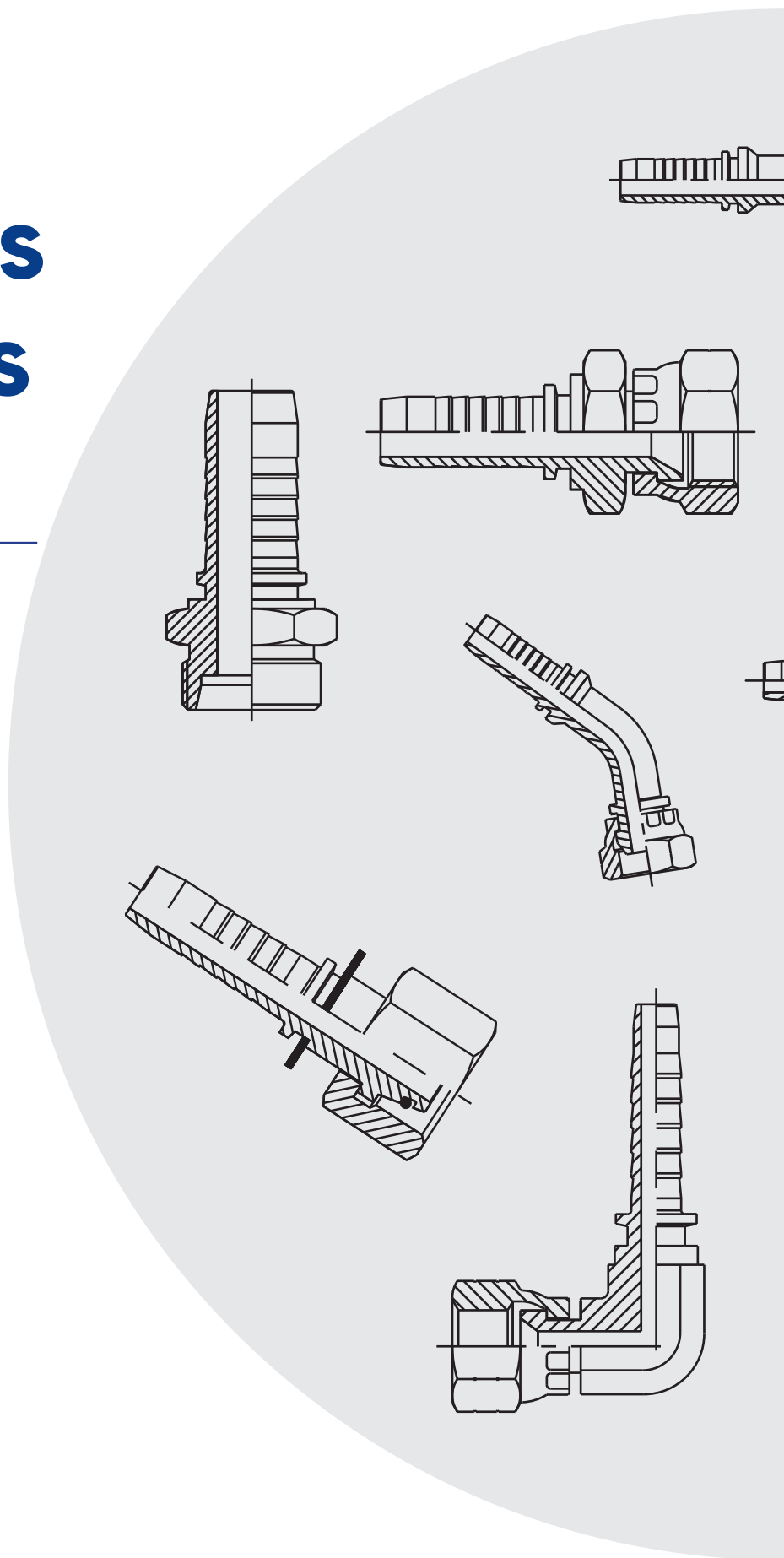

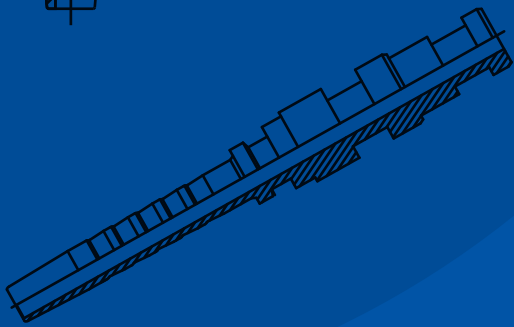
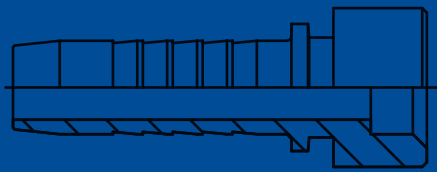
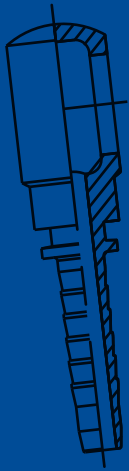
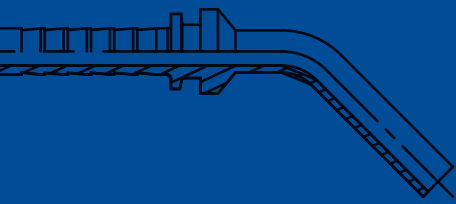
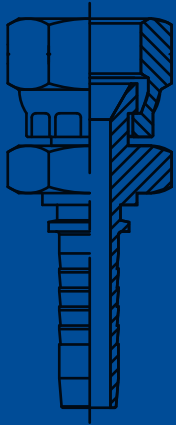

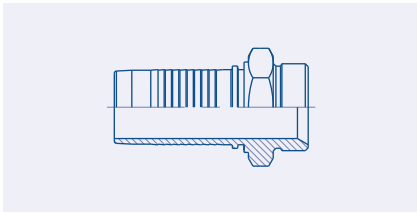

**Hilo Paralelo BSP Macho (AGR)**

23.0100

pág. 33

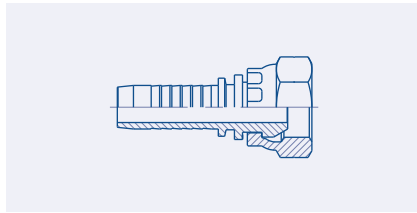

**Hilo Paralelo BSP Hembra Giratoria (DKR)**

23.3012

pág. 34

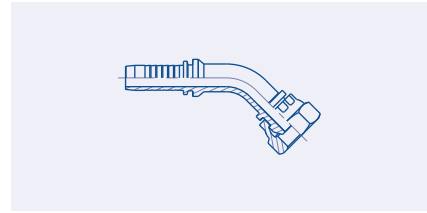

**Hilo Paralelo BSP Hembra Giratoria, Codo 45° (DKR 45°)**

23.3042

pág. 35

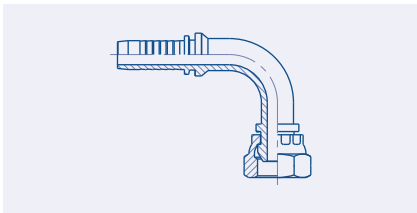

**Hilo Paralelo BSP Hembra Giratoria, Codo 90° (DKR 90°)**

23.3092

pág. 36

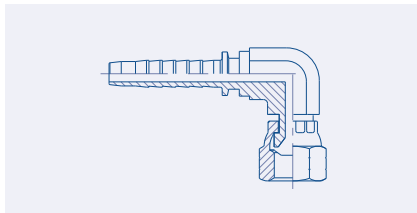

**Hilo Paralelo BSP Hembra Giratoria Compacta, Codo 90°**

23.3082

pág. 37

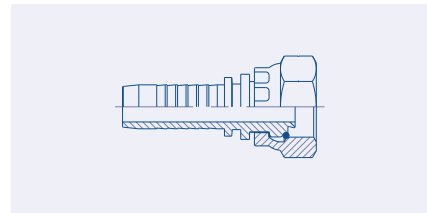

**Hilo Paralelo BSP Hembra Giratoria con O'ring (DKOR)**

23.3112

pág. 37

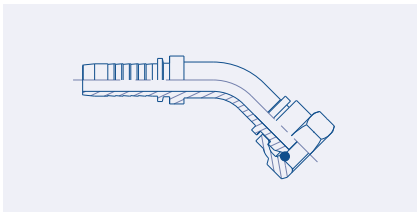

**Hilo Paralelo BSP Hembra Giratoria con O'ring, Codo 45° (DKOR 45°)**

23.3142

pág. 38

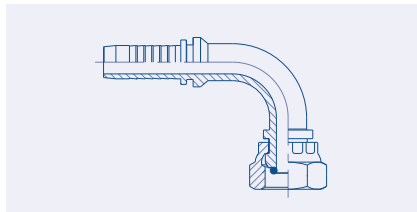

**Hilo Paralelo BSP Hembra Giratoria con O'ring, Codo 90° (DKOR 90°)**

23.3192

pág. 39

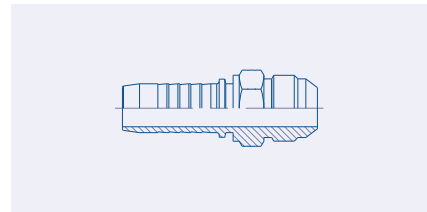

**Macho JIC 37° (AGJ)**

23.2000

pág. 40

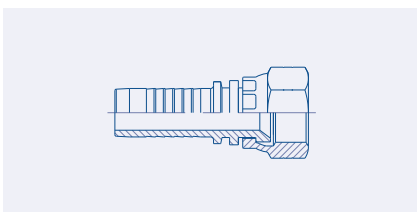

**Hembra giratoria JIC 37° (DKJ)**

23.4012

pág. 41

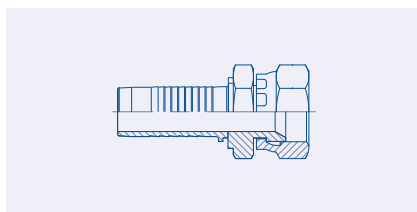

**Hembra Giratoria JIC 37° con Hexágono Trasero**

23.4H12

pág. 42

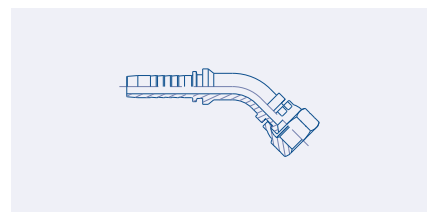

**Hembra Giratoria JIC 37°, Codo 45° (DKJ 45°)**

23.4042

pág. 43

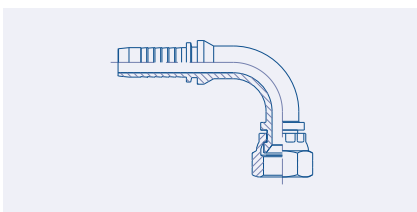

**Hembra Giratoria JIC 37°, Codo 90° (DKJ 90°)**

23.4092

pág. 44

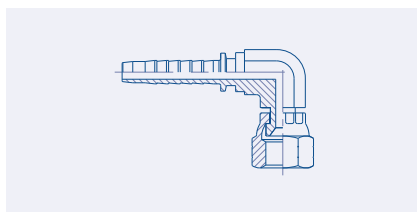

**Hembra Giratoria Compacta JIC 37°, Codo 90°**

23.4082

pág. 45

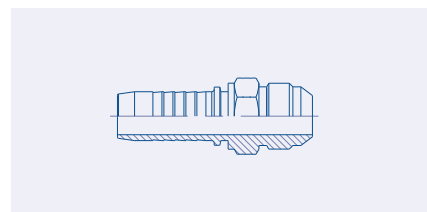

**Macho SAE 45°**

23.2S00

pág. 46

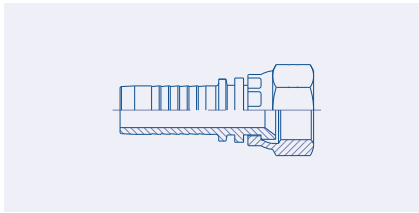

**Hembra Giratoria SAE 45°**  
23.4S12

pág. 46

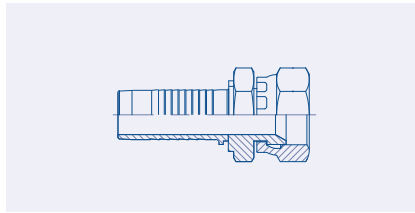

**Hembra Giratoria SAE 45° con Hexágono Trasero**

23.SH12

pág. 47



**Hembra Giratoria SAE 45°**  
23.4S42

pág. 47

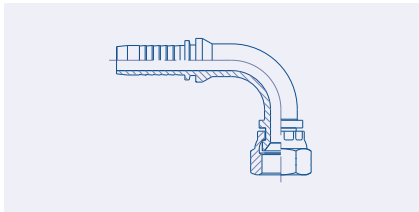

**Hembra Giratoria SAE 45°, Codo 90°**

23.4S92

pág. 48

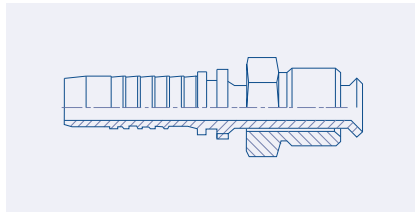

**Macho SAE Cono Invertido 45°**

23.2210

pág. 48

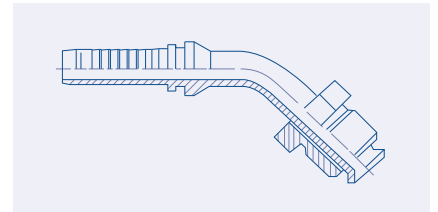

**Macho SAE Cono Invertido 45°, Codo 45°**

23.2240

pág. 49

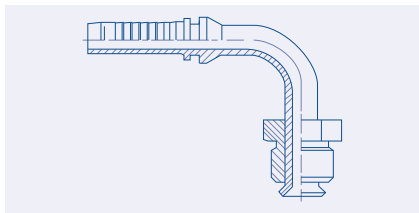

**Macho SAE Cono Invertido 45°, Codo 90°**

23.2290

pág. 49

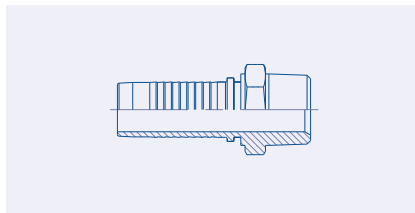

**Hilo NPTF Macho (AGN)**

23.0400

pág. 50

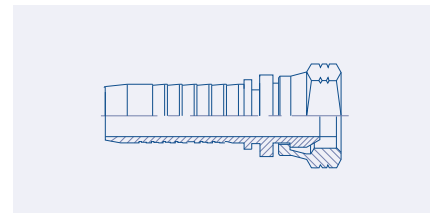

**Hilo NPSM Hembra Giratoria**

23.3010

pág. 51

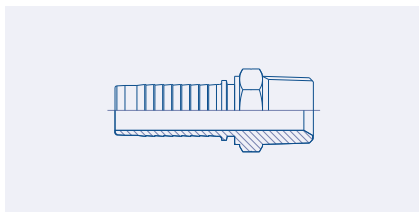

**Hilo Cónico BSPT Macho (AGR-K)**

23.0300

pág. 51

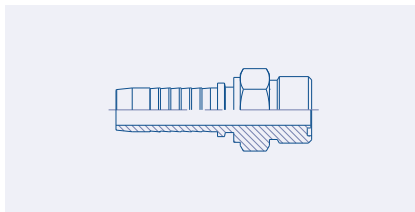

**Macho ORFS**

23.4000

pág. 52

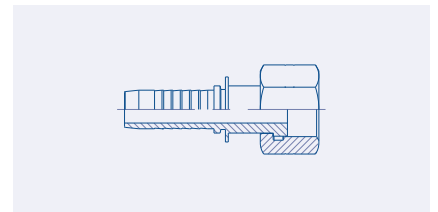

**Hembra Giratoria ORFS**

23.4414

pág. 53

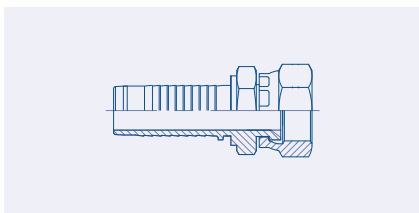

**Hembra Giratoria ORFS con Hexágono Trasero**

23.44H4

pág. 54

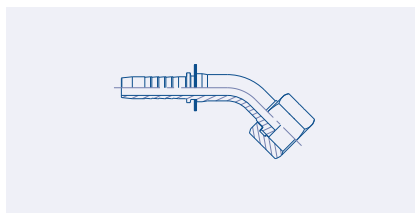

**Hembra Giratoria ORFS, Codo 45°**

23.4444

pág. 55

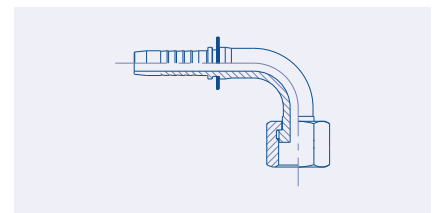

**Hembra Giratoria ORFS, Codo 45°**

23.4494

pág. 56

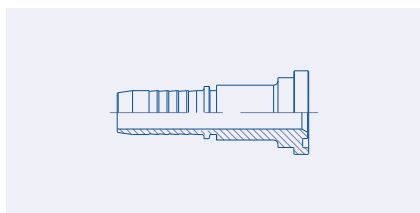

**Flange SAE Recta (código 61)  
3000 PSI (SFL)**

23.7013

pág. 57

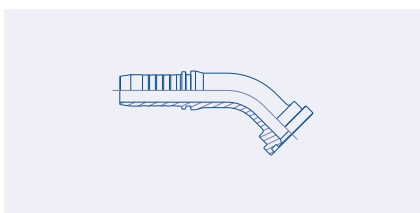

**Flange SAE (código 61) 3000  
PSI, Codo 45° (SFL 45°)**

23.7043

pág. 58

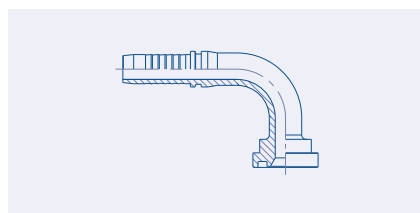

**Flange SAE (código 61) 3000  
PSI, Codo 90° (SFL 90°)**

23.7093

pág. 59

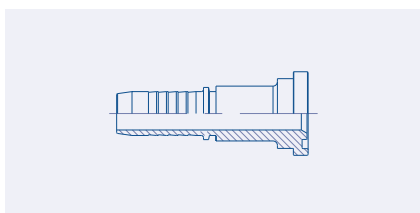

**Flange SAE Recta (código 62)  
6000 PSI (SFS)**

23.7016

pág. 60

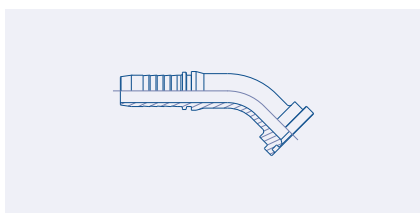

**Flange SAE (código 62) 6000  
PSI, Codo 45° (SFS 45°)**

23.7046

pág. 61

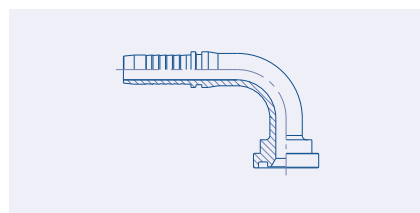

**Flange SAE (código 62) 6000  
PSI, codo 90° (SFS 90°)**

23.7096

pág. 62

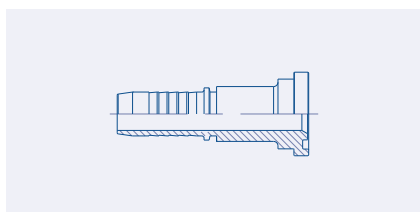

**Flange Recta SUPERCAT**

23.7116

pág. 63

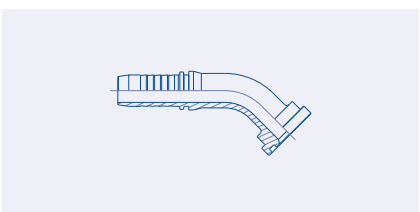

**Flange SUPERCAT, Codo 45°**

23.7146

pág. 63

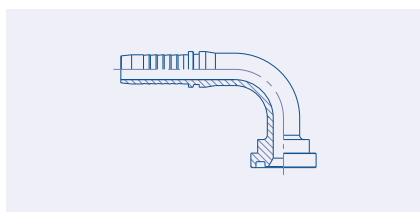

**Flange SUPERCAT, Codo 90°**

23.7196

pág. 64

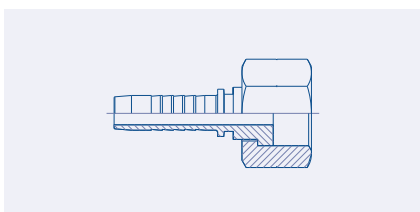

**Hembra Giratoria BSP Cara Plana**

23.3212

pág. 65

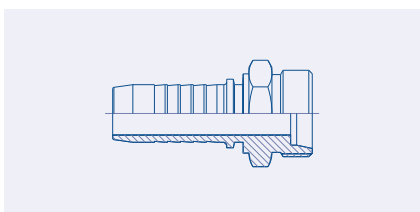

**Macho Métrico Serie Ligera  
Asiento Cono 24° (CEL)**

23.1000

pág. 66

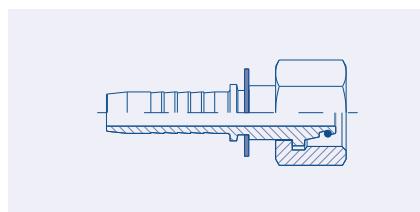

**Hembra Métrica Giratoria Serie  
Ligera Asiento Cono 24° (DKOL)**

23.5013

pág. 67

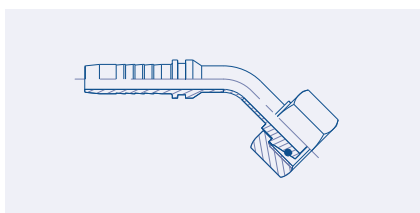

**Hembra Métrica Giratoria Serie  
Ligera Asiento Cono 24°, Codo  
45° (DKOL 45)**

23.5043

pág. 68

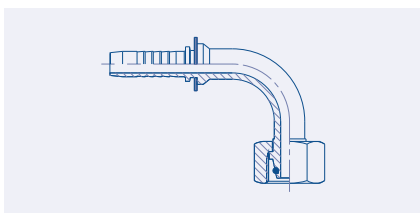

**Hembra Métrica Giratoria Serie  
Ligera Asiento Cono 24°, Codo  
90° (DKOL 90)**

23.5093

pág. 69

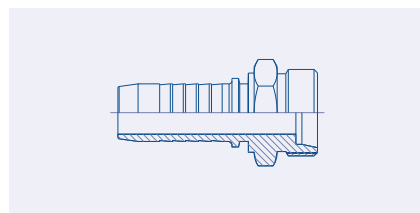

**Macho Métrico Serie Pesada  
Asiento Cono 24° (CES)**

23.1100

pág. 70

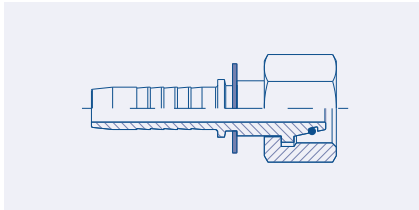

**Hembra Métrica Giratoria Serie Pesada Asiento Cono 24° (DKOS)**  
23.5113 pág. 71

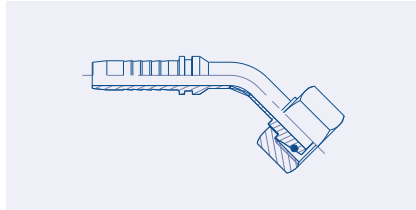

**Hembra Métrica Giratoria Serie Pesada Asiento Cono 24°, Codo 45° (DKOS 45)** 23.5143 pág. 72

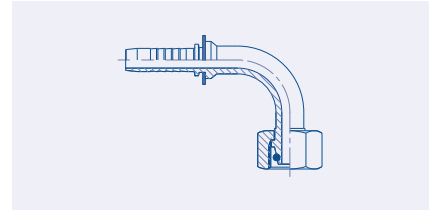

**Hembra Métrica Giratoria Serie Pesada Asiento Cono 24°, Codo 90° (DKOS 90)** 23.5193 pág. 73

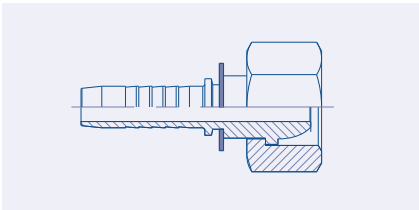

**Hembra Métrica Giratoria Asiento Cono 24°/60° (DKL)**  
23.5213 pág. 74

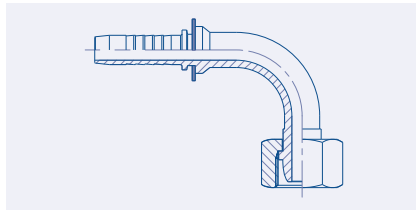

**Hembra Métrica Giratoria Asiento Cono 24°/60°, Codo 90° (DKL)**  
23.5293 pág. 74

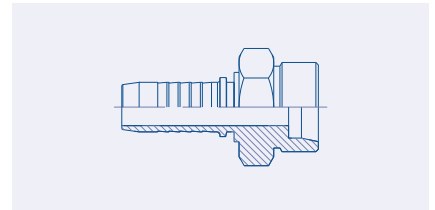

**Macho Métrico Serie Francesa Asiento Cono 24° (AGF)**  
23.1200 pág. 75

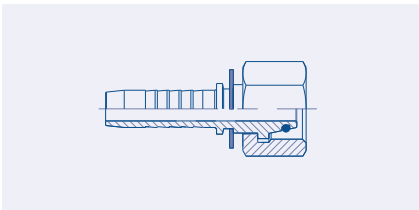

**Hembra Métrica Serie Francesa Asiento Cono 24° (DKF)**  
23.5513 pág. 75

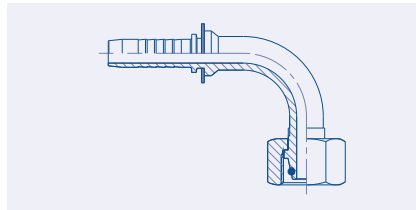

**Hembra Métrica Giratoria Serie Francesa Asiento Cono 24°, Codo 90° (DKF)** 23.5593 pág. 76

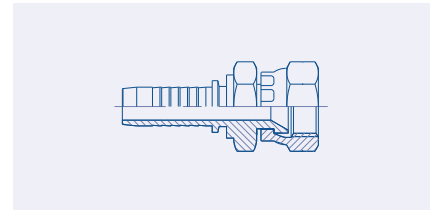

**Hembra Giratoria JIS Asiento Cono 60° (MITSUBISHI)**  
23.3712 pág. 76

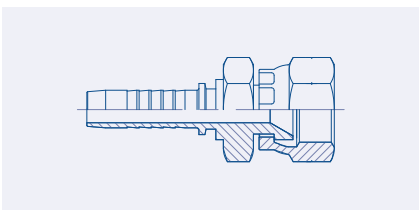

**Hembra Giratoria KOMATSU asiento Cono 60°**  
23.5911 pág. 77

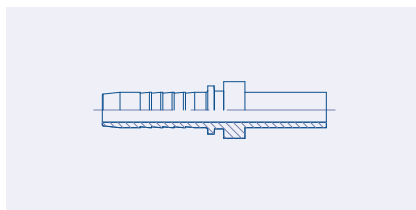

**Tubular Métrico (BEL)**  
23.6000 pág. 78

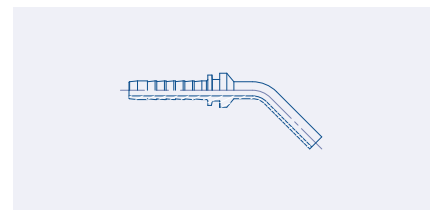

**Tubular Métrico, Codo 45° (BEL 45)**  
23.6040 pág. 79

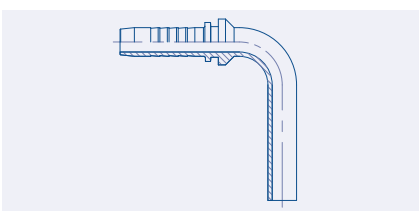

**Tubular Métrico, Codo 90° (BEL 90)**  
23.6090 pág. 80

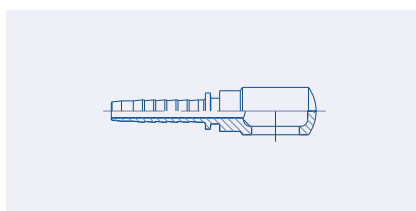

**Banjo Métrico (RNM)**  
23.6400 pág. 81

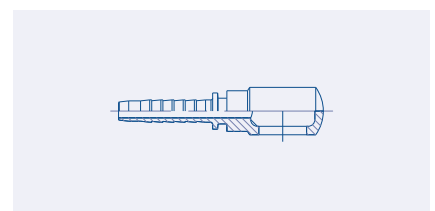

**Banjo BSP (RNR)**  
23.6500 pág. 82

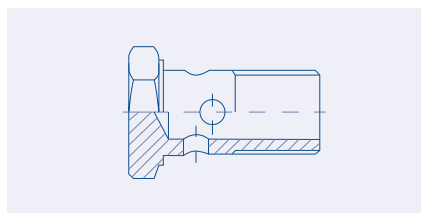

**Perno Banjo BSP**

88.1600

pág. 83

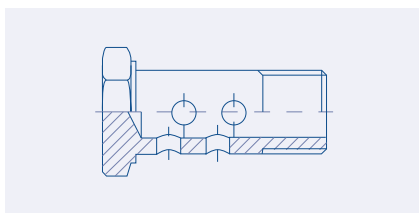

**Perno Banjo BSP Doble**

88.1602

pág. 83

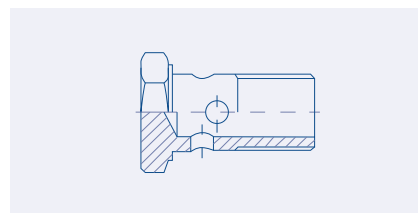

**Perno Banjo Métrico**

88.1650

pág. 84

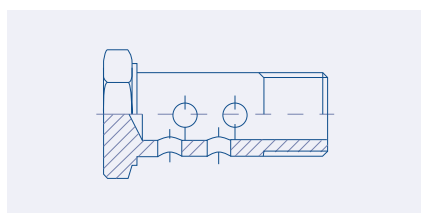

**Perno Banjo Métrico Doble**

88.1652

pág. 84

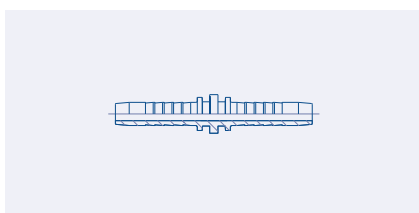

**Unión de Manguera**

23.8100

pág. 85

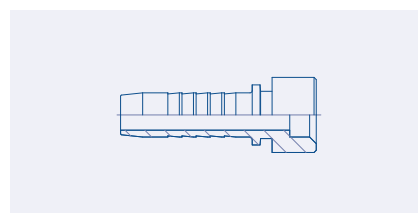

**Espiga Soldable**

23.8150

pág. 85

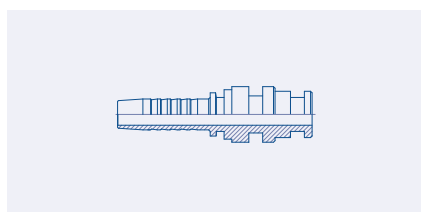

**Macho de Bloqueo**

23.8300

pág. 86

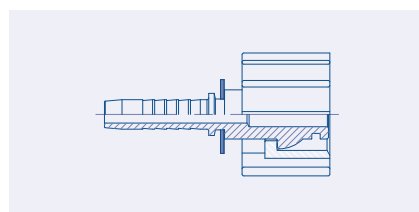

**Hembra Hidrolavadora giratoria (Karcher)**

23.6213

pág. 86

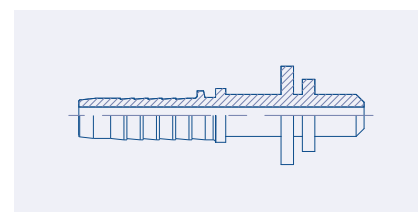

**Espiga Hidrolavadora con O'ring (Karcher)**

23.6214

pág. 87

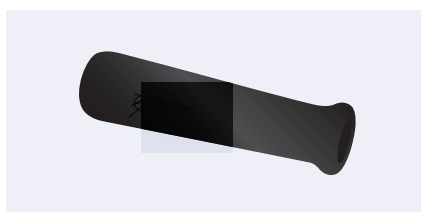

**Mango de Caucho Balwash**

11.800

pág. 87

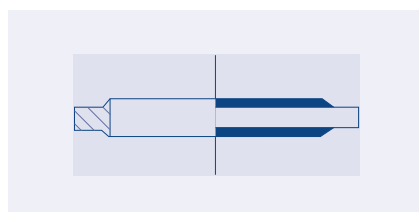

**Sellos Adheridos BSP (Bonded Seal)**

88.2003

pág. 88

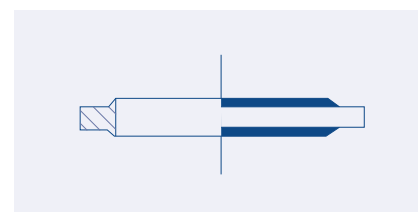

**Sellos Adheridos Métricos (Bonded Seal)**

88.2004

pág. 88

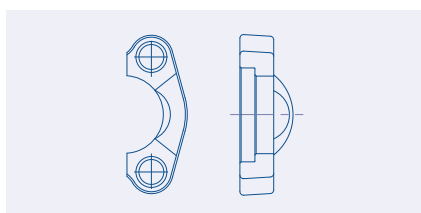

**Brida Dividida 3000 PSI (código 61)**

88.5300

pág. 89

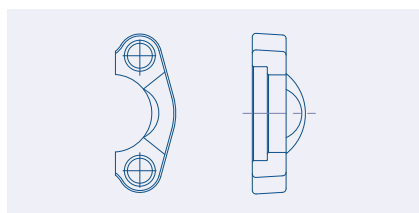

**Brida Dividida 6000 PSI (código 62)**

88.5600

pág. 89



# Hilo Paralelo BSP Macho (AGR)

23.0100.

ISO 12151-6 / ISO 8434-6 / BS 5200

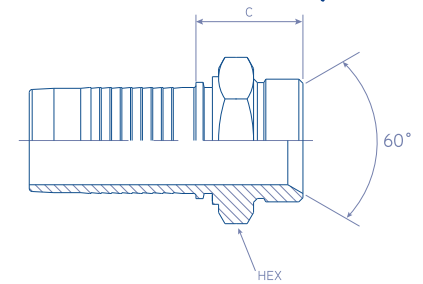

REFERENCIA	manguera	manguera Ø	hilo	Corte C	HEX
	tabla medidas	pulg.	pulg.	mm	mm
23.0100.0302	-3	3/16"	1/8" - 28	23.0	14
23.0100.0304	-3	3/16"	1/4" - 19	27.0	19
23.0100.0402	-4	1/4"	1/8" - 28	22.2	14
23.0100.0404	-4	1/4"	1/4" - 19	26.2	19
23.0100.0406	-4	1/4"	3/8" - 19	28.7	22
23.0100.0408	-4	1/4"	1/2" - 14	33.2	27
23.0100.0504	-5	5/16"	1/4" - 19	26.5	19
23.0100.0506	-5	5/16"	3/8" - 19	29.0	22
23.0100.0508	-5	5/16"	1/2" - 14	33.5	27
23.0100.0604	-6	3/8"	1/4" - 19	26.5	19
23.0100.0606	-6	3/8"	3/8" - 19	29.0	22
23.0100.0608	-6	3/8"	1/2" - 14	33.5	27
23.0100.0806	-8	1/2"	3/8" - 19	29.5	22
23.0100.0808	-8	1/2"	1/2" - 14	33.5	27
23.0100.0810	-8	1/2"	5/8" - 14	36.5	30
23.0100.0812	-8	1/2"	3/4" - 14	39.5	32
23.0100.1008	-10	5/8"	1/2" - 14	34.5	27
23.0100.1010	-10	5/8"	5/8" - 14	36.0	30
23.0100.1012	-10	5/8"	3/4" - 14	39.5	32
23.0100.1212	-12	3/4"	3/4" - 14	39.2	32
23.0100.1216	-12	3/4"	1" - 11	44.2	41
23.0100.1616	-16	1"	1" - 11	45.0	41
23.0100.1620	-16	1"	1 1/4" - 11	48.0	50
23.0100.2020	-20	1 1/4"	1 1/4" - 11	49.5	50
23.0100.2024	-20	1 1/4"	1 1/2" - 11	52.0	55
23.0100.2424	-24	1 1/2"	1 1/2" - 11	52.0	55
23.0100.2432	-24	1 1/2"	2" - 11	57.5	70
23.0100.3232	-32	2"	2" - 11	57.5	70

**MATERIAL:** Acero al carbono

**ACABADO:** Enchapado sin cromo-(VI)  
/ conforme a ROHS

**VERSIONES:** Acero inoxidable  
(agregue una 'S' al final de la  
REFERENCIA)

# Hilo Paralelo BSP Hembra Giratoria (DKR)

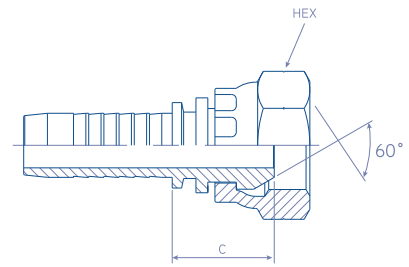

23.3012.

ISO 12151-6 / ISO 8434-6 / BS 5200

REFERENCIA	manguera	manguera Ø	hilo	Corte C	HEX
	tabla medidas	pulg.	pulg.	mm	mm
23.3012.0302	-3	3/16"	1/8" - 28	16.0	14
23.3012.0304	-3	3/16"	1/4" - 19	18.5	19
23.3012.0402	-4	1/4"	1/8" - 28	15.2	14
23.3012.0404	-4	1/4"	1/4" - 19	17.7	19
23.3012.0406	-4	1/4"	3/8" - 19	18.7	22
23.3012.0408	-4	1/4"	1/2" - 14	20.7	27
23.3012.0504	-5	5/16"	1/4" - 19	18.0	19
23.3012.0506	-5	5/16"	3/8" - 19	19.5	22
23.3012.0508	-5	5/16"	1/2" - 14	21.0	27
23.3012.0604	-6	3/8"	1/4" - 19	18.0	19
23.3012.0606	-6	3/8"	3/8" - 19	19.5	22
23.3012.0608	-6	3/8"	1/2" - 14	21.0	27
23.3012.0806	-8	1/2"	3/8" - 19	19.5	22
23.3012.0808	-8	1/2"	1/2" - 14	21.5	27
23.3012.0810	-8	1/2"	5/8" - 14	22.0	30
23.3012.0812	-8	1/2"	3/4" - 14	21.0	27
23.3012.1008	-10	5/8"	1/2" - 14	22.5	27
23.3012.1010	-10	5/8"	5/8" - 14	23.0	30
23.3012.1012	-10	5/8"	3/4" - 14	23.5	32
23.3012.1212	-12	3/4"	3/4" - 14	23.7	32
23.3012.1216	-12	3/4"	1" - 11	22.7	38
23.3012.1616	-16	1"	1" - 11	26.5	38
23.3012.1620	-16	1"	1.1/4" - 11	29.0	50
23.3012.2020	-20	1.1/4"	1.1/4" - 11	30.5	50
23.3012.2024	-20	1.1/4"	1.1/2" - 11	30.0	55
23.3012.2424	-24	1.1/2"	1.1/2" - 11	32.0	55
23.3012.2432	-24	1.1/2"	2" - 11	34.0	70
23.3012.3232	-32	2"	2" - 11	34.0	70
23.3012.4040	-40	2.1/2"	2.1/2" - 11	41.0	90
23.3012.4848	-48	3"	3" - 11	47.0	100

**MATERIAL:** Acero al carbono  
**ACABADO:** Enchapado sin cromo-(VI) / conforme a ROHS

**VERSIONES:** Acero inoxidable (agregue una 'S' al final de la REFERENCIA)

**NOTAS:** En tamaños más grandes, las tuercas pueden suministrarse con tuerca con seguro



# Hilo Paralelo BSP Hembra Giratoria, Codo 45° (DKR 45°)

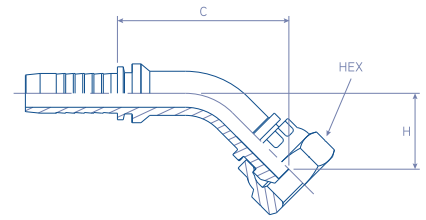

23.3042.

ISO 12151-6 / ISO 8434-6 / BS 5200

REFERENCIA	manguera	manguera Ø	hilo	Corte C	H	HEX
	tabla medidas	pulg.	pulg.	mm	mm	mm
23.3042.0302	-3	3/16"	1/8" - 28	30.0	12.5	14
23.3042.0304	-3	3/16"	1/4" - 19	33.5	13.0	19
23.3042.0402	-4	1/4"	1/8" - 28	29.0	12.5	14
23.3042.0404	-4	1/4"	1/4" - 19	33.5	13.0	19
23.3042.0406	-4	1/4"	3/8" - 19	34.2	14.4	22
23.3042.0408	-4	1/4"	1/2" - 14	38.0	16.0	27
23.3042.0504	-5	5/16"	1/4" - 19	33.5	13.0	19
23.3042.0506	-5	5/16"	3/8" - 19	42.5	19.0	22
23.3042.0508	-5	5/16"	1/2" - 14	42.5	19.0	27
23.3042.0604	-6	3/8"	1/4" - 19	33.5	13.0	19
23.3042.0606	-6	3/8"	3/8" - 19	40.0	14.7	22
23.3042.0608	-6	3/8"	1/2" - 14	38.6	15.8	27
23.3042.0806	-8	1/2"	3/8" - 19	34.2	15.0	22
23.3042.0808	-8	1/2"	1/2" - 14	46.0	18.0	27
23.3042.0810	-8	1/2"	5/8" - 14	55.0	23.0	27
23.3042.0812	-8	1/2"	3/4" - 14	56.0	24.0	32
23.3042.1008	-10	5/8"	1/2" - 14	46.5	18.0	27
23.3042.1010	-10	5/8"	5/8" - 14	60.5	23.3	27
23.3042.1012	-10	5/8"	3/4" - 14	64.0	26.9	32
23.3042.1212	-12	3/4"	3/4" - 14	67.5	24.5	32
23.3042.1216	-12	3/4"	1" - 11	70.0	26.0	38
23.3042.1616	-16	1"	1" - 11	83.6	33.8	38
23.3042.1620	-16	1"	1.1/4" - 11	92.3	41.7	50
23.3042.2020	-20	1.1/4"	1.1/4" - 11	97.0	37.5	50
23.3042.2024	-20	1.1/4"	1.1/2" - 11	102.0	42.0	55
23.3042.2424	-24	1.1/2"	1.1/2" - 11	119.0	49.2	55
23.3042.2432	-24	1.1/2"	2" - 11	125.0	55.0	70
23.3042.3232	-32	2"	2" - 11	149.8	60.0	70

**MATERIAL:** Acero al carbono  
**ACABADO:** Enchapado sin cromo-(VI) / conforme a ROHS

**VERSIONES:** Acero inoxidable (agregue una 'S' al final de la REFERENCIA)

**NOTAS:** En tamaños más grandes, las tuercas pueden suministrarse con tuerca con seguro

# Hilo Paralelo BSP Hembra Giratoria, Codo 90° (DKR 90°)

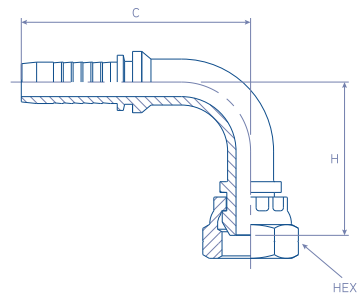

23.3092.

ISO 12151-6 / ISO 8434-6 / BS 5200

REFERENCIA	manguera tabla medidas	manguera Ø pulg.	hilo pulg.	Corte C mm	H mm	HEX mm
23.3092.0302	-3	3/16"	1/8" - 28	25.5	26.0	14
23.3092.0304	-3	3/16"	1/4" - 19	25.5	26.0	19
23.3092.0402	-4	1/4"	1/8" - 28	26.7	26.5	14
23.3092.0404	-4	1/4"	1/4" - 19	27.6	27,5	19
23.3092.0406	-4	1/4"	3/8" - 19	28.0	29,5	22
23.3092.0408	-4	1/4"	1/2" - 14	30.0	30.0	27
23.3092.0504	-5	5/16"	1/4" - 19	32.0	30.0	19
23.3092.0506	-5	5/16"	3/8" - 19	32.5	30.5	22
23.3092.0508	-5	5/16"	1/2" - 14	30.0	30.0	27
23.3092.0604	-6	3/8"	1/4" - 19	28.0	29,5	19
23.3092.0606	-6	3/8"	3/8" - 19	33.0	31,5	22
23.3092.0608	-6	3/8"	1/2" - 14	34.0	31,5	27
23.3092.0806	-8	1/2"	3/8" - 19	35.0	35.0	22
23.3092.0808	-8	1/2"	1/2" - 14	39,5	38,5	27
23.3092.0810	-8	1/2"	5/8" - 14	45.0	42.0	27
23.3092.0812	-8	1/2"	3/4" - 14	54.0	55.0	32
23.3092.1008	-10	5/8"	1/2" - 14	54.0	48.0	27
23.3092.1010	-10	5/8"	5/8" - 14	54.0	50.0	27
23.3092.1012	-10	5/8"	3/4" - 14	54.0	55.0	32
23.3092.1212	-12	3/4"	3/4" - 14	55,5	55.0	32
23.3092.1216	-12	3/4"	1" - 11	60,5	64.0	38
23.3092.1616	-16	1"	1" - 11	71,5	71.0	38
23.3092.1620	-16	1"	1.1/4" - 11	79,5	79,5	50
23.3092.2020	-20	1.1/4"	1.1/4" - 11	85,5	77.0	50
23.3092.2024	-20	1.1/4"	1.1/2" - 11	91,5	92.0	55
23.3092.2424	-24	1.1/2"	1.1/2" - 11	102.0	100.0	55
23.3092.2432	-24	1.1/2"	2" - 11	110.0	110.0	70
23.3092.3232	-32	2"	2" - 11	132.3	128.0	70

**MATERIAL:** Acero al carbono  
**ACABADO:** Enchapado sin cromo-(VI) / conforme a ROHS

**VERSIONES:** Acero inoxidable (agregue una 'S' al final de la REFERENCIA)

**NOTAS:** En tamaños más grandes, las tuercas pueden suministrarse con tuerca con seguro



# Hilo Paralelo BSP Hembra Giratoria Compacta, Codo 90°

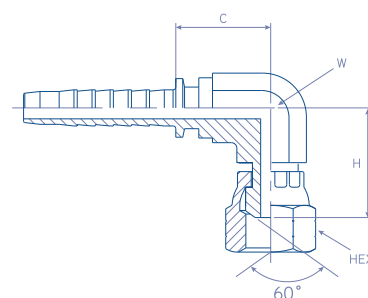

23.3082.

ISO 12151-6 / ISO 8434-6 / BS 5200

REFERENCIA	manguera tabla medidas	manguera Ø pulg.	hilo pulg.	Corte C mm	H mm	W mm	HEX mm
23.3082.0404	-4	1/4"	1/4" - 19	17.5	23.5	11	19
23.3082.0606	-6	3/8"	3/8" - 19	21.5	25.5	16	22
23.3082.0808	-8	1/2"	1/2" - 14	25.5	28.0	19	27
23.3082.1010	-10	5/8"	5/8" - 14	22.5	27.0	22	30
23.3082.1212	-12	3/4"	3/4" - 14	26.5	36.0	27	32
23.3082.1616	-16	1"	1" - 11	30.5	34.5	33	38

**MATERIAL:** Acero al carbono

**ACABADO:** Enchapado sin cromo-(VI) / conforme a ROHS

**VERSIONES:** Acero inoxidable (agregue una 'S' al final de la REFERENCIA)

# Hilo Paralelo BSP Hembra Giratoria con O'ring (DKOR)

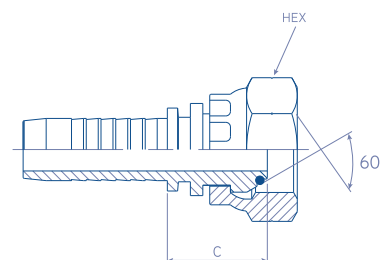

23.3112.

ISO 12151-6 / ISO 8434-6 / BS 5200

REFERENCIA	manguera tabla medidas	manguera Ø pulg.	hilo pulg.	Corte C mm	HEX mm
23.3112.0404	-4	1/4"	1/4" - 19	17.7	19
23.3112.0606	-6	3/8"	3/8" - 19	19.5	22
23.3112.0808	-8	1/2"	1/2" - 14	21.5	27
23.3112.1010	-10	5/8"	5/8" - 14	23.0	30
23.3112.1212	-12	3/4"	3/4" - 14	23.7	32
23.3112.1216	-12	3/4"	1" - 11	22.7	38
23.3112.1616	-16	1"	1" - 11	26.5	38
23.3112.1620	-16	1"	1 1/4" - 11	29.0	50
23.3112.2020	-20	1 1/4"	1 1/4" - 11	30.5	50
23.3112.2024	-20	1 1/4"	1 1/2" - 11	30.0	55
23.3112.2424	-24	1 1/2"	1 1/2" - 11	32.0	55
23.3112.2432	-24	1 1/2"	2" - 11	34.0	70
23.3112.3232	-32	2"	2" - 11	34.0	70

**MATERIAL:** Acero al carbono  
**ACABADO:** Enchapado sin cromo-(VI) / conforme a ROHS

**VERSIONES:** Acero inoxidable (agregue una 'S' al final de la REFERENCIA)

**NOTAS:** En tamaños más grandes, las tuercas pueden suministrarse con tuerca con seguro

# Hilo Paralelo BSP Hembra Giratoria con O' Ring, Codo 45° (DKOR 45°)

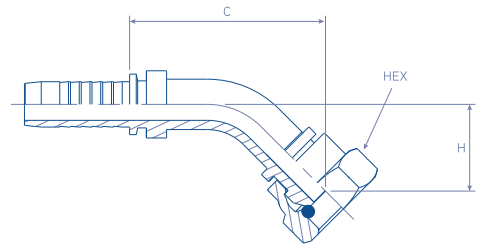

23.3142.

ISO 12151-6 / ISO 8434-6 / BS 5200

REFERENCIA	manguera tabla medidas	manguera Ø pulg.	hilo pulg.	Corte C mm	H mm	HEX mm
23.3142.0404	-4	1/4"	1/4" - 19	33.5	13.0	19
23.3142.0606	-6	3/8"	3/8" - 19	40.0	14.7	22
23.3142.0808	-8	1/2"	1/2" - 14	46.0	18.0	27
23.3142.1010	-10	5/8"	5/8" - 14	60.5	23.3	27
23.3142.1212	-12	3/4"	3/4" - 14	67.5	24.5	32
23.3142.1216	-12	3/4"	1" - 11	70.0	26.0	38
23.3142.1616	-16	1"	1" - 11	83.6	33.8	38
23.3142.1620	-16	1"	1 1/4" - 11	92.3	41.7	50
23.3142.2020	-20	1 1/4"	1 1/4" - 11	97.0	37.5	50
23.3142.2024	-20	1 1/4"	1 1/2" - 11	102.0	42.0	55
23.3142.2424	-24	1 1/2"	1 1/2" - 11	119.0	49.2	55
23.3142.2432	-24	1 1/2"	2" - 11	125.0	55.0	70
23.3142.3232	-32	2"	2" - 11	149.8	60.0	70

**MATERIAL:** Acero al carbono  
**ACABADO:** Enchapado sin cromo-(VI) / conforme a ROHS

**VERSIONES:** Acero inoxidable (agregue una 'S' al final de la REFERENCIA)

**NOTAS:** En tamaños más grandes, las tuercas pueden suministrarse con tuerca con seguro



# Hilo Paralelo BSP Hembra Giratoria con O' Ring, Codo 90° (DKOR 90°)

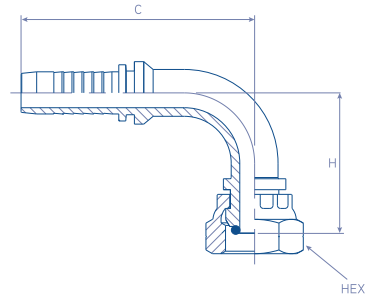

23.3192.

ISO 12151-6 / ISO 8434-6 / BS 5200

REFERENCIA	manguera tabla medidas	manguera Ø pulg.	hilo pulg.	Corte C mm	H mm	HEX mm
23.3192.0404	-4	1/4"	1/4" - 19	27.6	27.5	19
23.3192.0606	-6	3/8"	3/8" - 19	33.0	31.5	22
23.3192.0808	-8	1/2"	1/2" - 14	39.5	38.5	27
23.3192.1010	-10	5/8"	5/8" - 14	54.0	50.0	27
23.3192.1212	-12	3/4"	3/4" - 14	55.5	55.0	32
23.3192.1216	-12	3/4"	1" - 11	60.5	64.0	38
23.3192.1616	-16	1"	1" - 11	71.5	71.0	38
23.3192.1620	-16	1"	1.1/4" - 11	79.5	79.5	50
23.3192.2020	-20	1.1/4"	1.1/4" - 11	85.5	77.0	50
23.3192.2024	-20	1.1/4"	1.1/2" - 11	91.5	92.0	55
23.3192.2424	-24	1.1/2"	1.1/2" - 11	102.0	100.0	55
23.3192.2432	-24	1.1/2"	2" - 11	110.0	110.0	70
23.3192.3232	-32	2"	2" - 11	132.3	128.0	70

**MATERIAL:** Acero al carbono  
**ACABADO:** Enchapado sin  
cromo-(VI) / conforme a ROHS

**VERSIONES:** Acero inoxidable  
(agregue una 'S' al final de la  
REFERENCIA)

**NOTAS:** En tamaños más grandes,  
las tuercas pueden suministrarse con  
tuerca con seguro

# Macho JIC 37° (AGJ)

23.2000.

ISO 12151-5 / ISO 8434-2 / SAE J516 / SAE J514

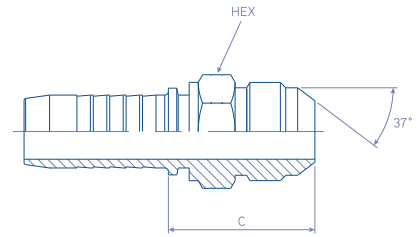

REFERENCIA	manguera	manguera Ø	hilo	Corte C	HEX
	tabla medidas	pulg.	pulg.	mm	mm
23.2000.0304	-3	3/16"	7/16" - 20	26.5	12
23.2000.0404	-4	1/4"	7/16" - 20	25.7	12
23.2000.0405	-4	1/4"	1/2" - 20	26.2	14
23.2000.0406	-4	1/4"	9/16" - 18	26.2	17
23.2000.0505	-5	5/16"	1/2" - 20	26.5	14
23.2000.0506	-5	5/16"	9/16" - 18	27.1	17
23.2000.0606	-6	3/8"	9/16" - 18	27.1	17
23.2000.0608	-6	3/8"	3/4" - 16	30.7	19
23.2000.0610	-6	3/8"	7/8" - 14	35.3	24
23.2000.0808	-8	1/2"	3/4" - 16	31.2	19
23.2000.0810	-8	1/2"	7/8" - 14	35.8	24
23.2000.0812	-8	1/2"	1.1/16" - 12	39.4	27
23.2000.1008	-10	5/8"	3/4" - 16	33.7	24
23.2000.1010	-10	5/8"	7/8" - 14	37.3	24
23.2000.1012	-10	5/8"	1.1/16" - 12	40.9	27
23.2000.1210	-12	3/4"	7/8" - 14	37.5	27
23.2000.1212	-12	3/4"	1.1/16" - 12	40.6	27
23.2000.1214	-12	3/4"	1.3/16" - 12	43.3	32
23.2000.1216	-12	3/4"	1.5/16" - 12	46.0	36
23.2000.1616	-16	1"	1.5/16" - 12	46.8	36
23.2000.1620	-16	1"	1.5/8" - 12	49.0	46
23.2000.2020	-20	1.1/4"	1.5/8" - 12	52.3	46
23.2000.2024	-20	1.1/4"	1.7/8" - 12	55.0	50
23.2000.2424	-24	1.1/2"	1.7/8" - 12	55.0	50
23.2000.2432	-24	1.1/2"	2.1/2" - 12	65.9	65
23.2000.3232	-32	2"	2.1/2" - 12	65.9	65

**MATERIAL:** Acero al carbono

**ACABADO:** Enchapado sin cromo-(VI) / conforme a ROHS

**VERSIONES:** Acero inoxidable (agregue una 'S' al final de la REFERENCIA)

# Hembra Giratoria JIC 37° (DKJ)

23.4012.

ISO 12151-5 / ISO 8434-2 / SAE J516 / SAE J514

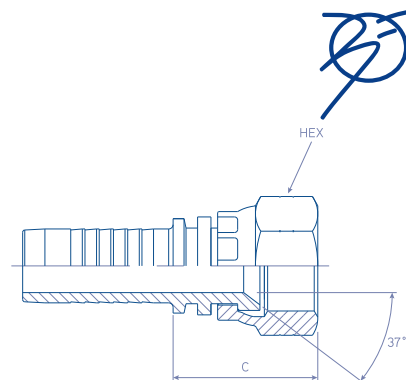

REFERENCIA	manguera	manguera Ø	hilo	Corte C	HEX
	tabla medidas	pulg.	pulg.	mm	mm
23.4012.0304	-3	3/16"	7/16" - 20	15.0	14
23.4012.0404	-4	1/4"	7/16" - 20	14.7	14
23.4012.0405	-4	1/4"	1/2" - 20	15.2	17
23.4012.0406	-4	1/4"	9/16" - 18	15.2	19
23.4012.0505	-5	5/16"	1/2" - 20	15.5	17
23.4012.0506	-5	5/16"	9/16" - 18	15.5	19
23.4012.0606	-6	3/8"	9/16" - 18	15.5	19
23.4012.0608	-6	3/8"	3/4" - 16	17.5	22
23.4012.0610	-6	3/8"	7/8" - 14	18.5	27
23.4012.0806	-8	1/2"	9/16" - 18	16.0	19
23.4012.0808	-8	1/2"	3/4" - 16	18.5	22
23.4012.0810	-8	1/2"	7/8" - 14	19.0	27
23.4012.0812	-8	1/2"	1.1/16" - 12	20.5	32
23.4012.1008	-10	5/8"	3/4" - 16	19.0	22
23.4012.1010	-10	5/8"	7/8" - 14	19.5	27
23.4012.1012	-10	5/8"	1.1/16" - 12	21.0	32
23.4012.1210	-12	3/4"	7/8" - 14	19.7	27
23.4012.1212	-12	3/4"	1.1/16" - 12	21.2	32
23.4012.1214	-12	3/4"	1.3/16" - 12	21.2	38
23.4012.1216	-12	3/4"	1.5/16" - 12	21.7	38
23.4012.1612	-16	1"	1.1/16" - 12	22.5	32
23.4012.1616	-16	1"	1.5/16" - 12	22.5	38
23.4012.1620	-16	1"	1.5/8" - 12	23.5	50
23.4012.2020	-20	1.1/4"	1.5/8" - 12	25.0	50
23.4012.2024	-20	1.1/4"	1.7/8" - 12	26.0	57
23.4012.2424	-24	1.1/2"	1.7/8" - 12	26.0	57
23.4012.2432	-24	1.1/2"	2.1/2" - 12	30.5	75
23.4012.3232	-32	2"	2.1/2" - 12	31.5	75

**MATERIAL:** Acero al carbono  
**ACABADO:** Enchapado sin cromo-(VI) / conforme a ROHS

**VERSIONES:** Acero inoxidable (agregue una 'S' al final de la REFERENCIA)

**NOTAS:** En tamaños más grandes, las tuercas pueden suministrarse con tuerca con seguro

# Hembra Giratoria JIC 37° con Hexágono Trasero

23.4H12.

ISO 12151-5 / ISO 8434-2 / SAE J516 / SAE J514

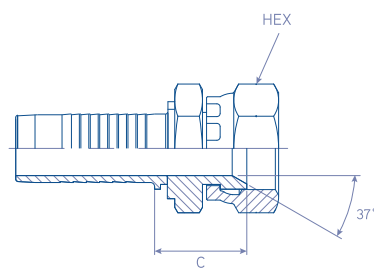

REFERENCIA	manguera tabla medidas	manguera Ø pulg.	hilo pulg.	Corte C mm	W mm	HEX mm
23.4H12.0304	-3	3/16"	7/16" - 20	21.5	12	14
23.4H12.0404	-4	1/4"	7/16" - 20	20.7	14	14
23.4H12.0405	-4	1/4"	1/2" - 20	20.7	14	16
23.4H12.0406	-4	1/4"	9/16" - 18	22.7	14	19
23.4H12.0506	-5	5/16"	9/16" - 18	22.7	14	19
23.4H12.0606	-6	3/8"	9/16" - 18	21.0	17	19
23.4H12.0608	-6	3/8"	3/4" - 16	26.3	19	22
23.4H12.0610	-6	3/8"	7/8" - 14	28.0	22	27
23.4H12.0808	-8	1/2"	3/4" - 16	26.0	22	22
23.4H12.0810	-8	1/2"	7/8" - 14	29.0	22	27
23.4H12.0812	-8	1/2"	1.1/16" - 12	33.0	25	32
23.4H12.1010	-10	5/8"	7/8" - 14	28.5	22	27
23.4H12.1012	-10	5/8"	1.1/16" - 12	33.5	27	32
23.4H12.1212	-12	3/4"	1.1/16" - 12	33.7	27	32
23.4H12.1214	-12	3/4"	1.3/16" - 12	35.2	32	38
23.4H12.1216	-12	3/4"	1.5/16" - 12	35.2	32	38
23.4H12.1616	-16	1"	1.5/16" - 12	35.5	32	38
23.4H12.1620	-16	1"	1.5/8" - 12	40.5	42	50
23.4H12.2020	-20	1.1/4"	1.5/8" - 12	42.0	42	50
23.4H12.2424	-24	1.1/2"	1.7/8" - 12	45.0	50	57
23.4H12.3232	-32	2"	2.1/2" - 12	49.0	64	75

**MATERIAL:** Acero al carbono

**ACABADO:** Enchapado sin cromo-(VI) / conforme a ROHS

**VERSIONES:** Acero inoxidable (agregue una 'S' al final de la REFERENCIA)



# Hembra Giratoria JIC 37°, Codo 45° (DKJ 45°)

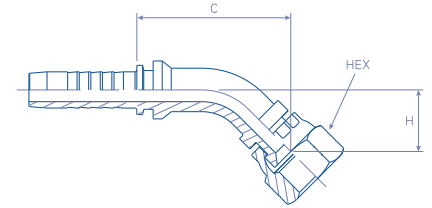

23.4042.

ISO 12151-5 / ISO 8434-2 / SAE J516 / SAE J514

REFERENCIA	manguera tabla medidas	manguera Ø pulg.	hilo pulg.	Corte C mm	H mm	HEX mm
23.4042.0304	-3	3/16"	7/16" - 20	25.0	14.5	14
23.4042.0404	-4	1/4"	7/16" - 20	35.0	14.5	14
23.4042.0405	-4	1/4"	1/2" - 20	35.0	14.5	16
23.4042.0406	-4	1/4"	9/16" - 18	35.0	13.0	19
23.4042.0505	-5	5/16"	1/2" - 20	35.0	14.5	16
23.4042.0506	-5	5/16"	9/16" - 18	38.5	14.5	19
23.4042.0606	-6	3/8"	9/16" - 18	38.5	14.5	19
23.4042.0608	-6	3/8"	3/4" - 16	50.0	15.5	22
23.4042.0610	-6	3/8"	7/8" - 14	40.5	16.5	27
23.4042.0808	-8	1/2"	3/4" - 16	44.4	17.5	22
23.4042.0810	-8	1/2"	7/8" - 14	50.5	21.3	27
23.4042.0812	-8	1/2"	1.1/16" - 12	59.0	25.0	32
23.4042.1010	-10	5/8"	7/8" - 14	52.0	25.0	27
23.4042.1012	-10	5/8"	1.1/16" - 12	64.0	26.5	32
23.4042.1212	-12	3/4"	1.1/16" - 12	67.5	27.0	32
23.4042.1214	-12	3/4"	13/16" - 12	68.0	28.0	38
23.4042.1216	-12	3/4"	1.5/16" - 12	72.0	30.0	38
23.4042.1616	-16	1"	1.5/16" - 12	83.5	32.0	38
23.4042.1620	-16	1"	1.5/8" - 12	83.0	36.0	50
23.4042.2020	-20	1.1/4"	1.5/8" - 12	97.0	37.0	50
23.4042.2424	-24	1.1/2"	1.7/8" - 12	102.0	38.0	57
23.4042.2432	-24	1.1/2"	2.1/2" - 12	119.0	49.2	57
23.4042.3232	-32	2"	2.1/2" - 12	152.0	69.0	75

**MATERIAL:** Acero al carbono  
**ACABADO:** Enchapado sin cromo-(VI) / conforme a ROHS

**VERSIONES:** Acero inoxidable (agregue una 'S' al final de la REFERENCIA)

**NOTAS:** En tamaños más grandes, las tuercas pueden suministrarse con tuerca con seguro

# Hembra Giratoria JIC 37°, Codo 90° (DKJ 90°)

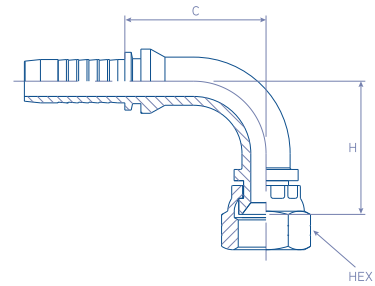

23.4092.

ISO 12151-5 / ISO 8434-2 / SAE J516 / SAE J514

REFERENCIA	manguera tabla medidas	manguera Ø pulg.	hilo pulg.	Corte C mm	H mm	HEX mm
23.4092.0304	-3	3/16"	7/16" - 20	27.2	29.0	14
23.4092.0404	-4	1/4"	7/16" - 20	30.0	31.0	14
23.4092.0405	-4	1/4"	1/2" - 20	30.8	30.0	16
23.4092.0406	-4	1/4"	9/16" - 18	28.2	28.0	19
23.4092.0505	-5	5/16"	1/2" - 20	32.0	33.0	17
23.4092.0506	-5	5/16"	9/16" - 18	27.0	23.5	19
23.4092.0606	-6	3/8"	9/16" - 18	34.0	30.0	19
23.4092.0608	-6	3/8"	3/4" - 16	35.0	30.0	22
23.4092.0610	-6	3/8"	7/8" - 14	37.1	38.0	27
23.4092.0808	-8	1/2"	3/4" - 16	39.5	38.0	22
23.4092.0810	-8	1/2"	7/8" - 14	36.8	40.5	27
23.4092.0812	-8	1/2"	1.1/16" - 12	46.5	51.0	32
23.4092.1010	-10	5/8"	7/8" - 14	54.0	52.0	27
23.4092.1012	-10	5/8"	1.1/16" - 12	54.0	55.0	32
23.4092.1210	-12	3/4"	7/8" - 14	54.2	55.0	27
23.4092.1212	-12	3/4"	1.1/16" - 12	55.5	55.0	32
23.4092.1214	-12	3/4"	1.3/16" - 12	55.5	57.0	38
23.4092.1216	-12	3/4"	1.5/16" - 12	55.5	60.0	38
23.4092.1616	-16	1"	1.5/16" - 12	71.5	71.0	38
23.4092.1620	-16	1"	1.5/8" - 12	79.5	79.5	50
23.4092.2020	-20	1.1/4"	1.5/8" - 12	85.5	77.0	50
23.4092.2024	-20	1.1/4"	1.7/8" - 12	86.5	90.0	57
23.4092.2424	-24	1.1/2"	1.7/8" - 12	102.0	100.0	57
23.4092.2432	-24	1.1/2"	2.1/2" - 12	118.0	120.0	75
23.4092.3232	-32	2"	2.1/2" - 12	130.5	140.0	75

**MATERIAL:** Acero al carbono  
**ACABADO:** Enchapado sin cromo-(VI) / conforme a ROHS

**VERSIONES:** Acero inoxidable (agregue una 'S' al final de la REFERENCIA)

**NOTAS:** En tamaños más grandes, las tuercas pueden suministrarse con tuerca con seguro



# Hembra Giratoria Compacta JIC 37°, Codo 90°

23.4082.

ISO 12151-5 / ISO 8434-2 / SAE J516 / SAE J514

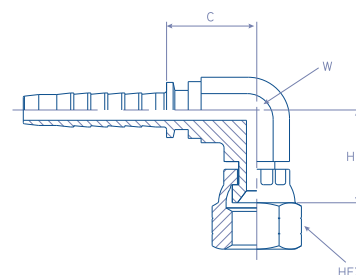

REFERENCIA	manguera tabla medidas	manguera Ø pulg.	hilo pulg.	Corte C mm	H mm	HEX mm
23.4082.0404	-4	1/4"	7/16" - 20	18.5	19.6	14
23.4082.0405	-4	1/4"	1/2" - 20	18.5	21.5	16
23.4082.0406	-4	1/4"	9/16" - 18	18.5	21.8	19
23.4082.0606	-6	3/8"	9/16" - 18	21.5	25.5	19
23.4082.0608	-6	3/8"	3/4" - 16	21.5	26.5	22
23.4082.0808	-8	1/2"	3/4" - 16	25.5	29.5	22
23.4082.0810	-8	1/2"	7/8" - 14	25.5	28	27
23.4082.1212	-12	3/4"	1.1/16" - 12	28.5	30.7	32
23.4082.1616	-16	1"	1.5/16" - 12	30.5	33.5	38

**MATERIAL:** Acero al carbono

**ACABADO:** Enchapado sin cromo-(VI) / conforme a ROHS

**VERSIONES:** Acero inoxidable (agregue una 'S' al final de la REFERENCIA)

# Macho SAE 45°

23.2S00.

SAE J512 / SAE J513

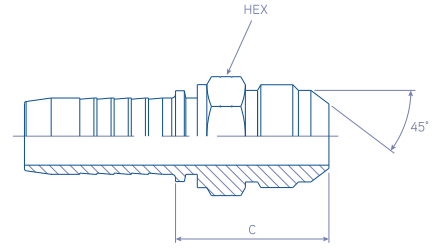

REFERENCIA	manguera tabla medidas	manguera Ø pulg.	Hilo	Corte C mm	HEX mm
23.2S00.0606	-6	3/8"	5/8" - 18 UNF	27.1	17
23.2S00.1212	-12	3/4"	1.1/16" - 14 UNS	40.6	27

**MATERIAL:** Acero al carbono

**ACABADO:** Enchapado sin cromo-(VI) / conforme a ROHS

**VERSIONES:** Acero inoxidable (agregue una 'S' al final de la REFERENCIA)

# Hembra Giratoria SAE 45°

23.4S12.

SAE J512 / SAE J513

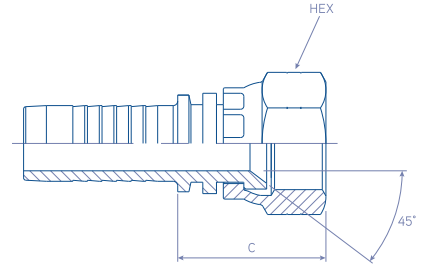

REFERENCIA	manguera tabla medidas	manguera Ø pulg.	Hilo	Corte C mm	HEX mm
23.4S12.0506	-5	5/16"	5/8" - 18 UNF	17.0	22
23.4S12.0606	-6	3/8"	5/8" - 18 UNF	17.0	22
23.4S12.1212	-12	3/4"	1.1/16" - 14 UNS	21.2	32

**MATERIAL:** Acero al carbono

**ACABADO:** Enchapado sin cromo-(VI) / conforme a ROHS

**VERSIONES:** Acero inoxidable (agregue una 'S' al final de la REFERENCIA)

**NOTAS:** En tamaños más grandes, las tuercas pueden suministrarse con tuerca con seguro



# Hembra Giratoria SAE 45° con Hexágono Trasero

23.SH12.

SAE J512 / SAE J513

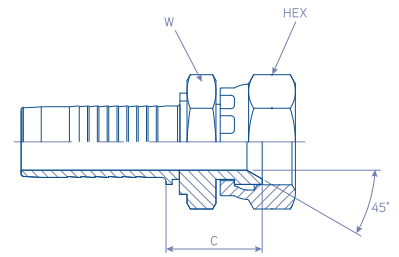

REFERENCIA	manguera tabla medidas	manguera Ø pulg.	Hilo	Corte C mm	W mm	HEX mm
23.SH12.0606	-6	3/8"	5/8" - 18 UNF	26.3	19	22
23.SH12.1212	-12	3/4"	1.1/16" - 14 UNS	33.7	27	32

**MATERIAL:** Acero al carbono

**ACABADO:** Enchapado sin cromo-(VI) / conforme a ROHS

**VERSIONES:** Acero inoxidable (agregue una 'S' al final de la REFERENCIA)

# Hembra Giratoria SAE 45°

23.4S42.

SAE J512 / SAE J513

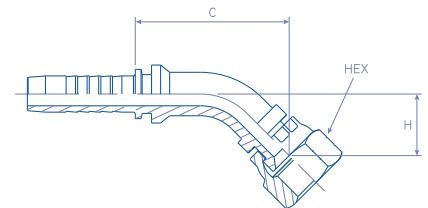

REFERENCIA	manguera tabla medidas	manguera Ø pulg.	Hilo	Corte C mm	H mm	HEX mm
23.4S42.0606	-6	3/8"	5/8" - 18 UNF	39.5	15.5	22
23.4S42.1212	-12	3/4"	1.1/16" - 14 UNS	67.5	27.0	32

**MATERIAL:** Acero al carbono

**ACABADO:** Enchapado sin cromo-(VI) / conforme a ROHS

**VERSIONES:** Acero inoxidable (agregue una 'S' al final de la REFERENCIA)

**NOTAS:** En tamaños más grandes, las tuercas pueden suministrarse con tuerca con seguro

# Hembra Giratoria SAE 45°, Codo 90°

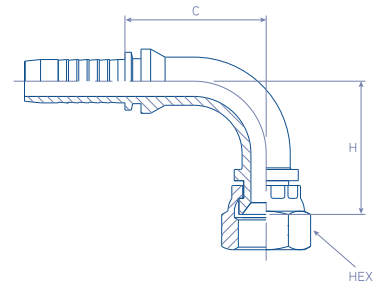

23.4S92.

SAE J512 / SAE J513

REFERENCIA	manguera tabla medidas	manguera Ø pulg.	Hilo	Corte C mm	H mm	HEX mm
23.4S92.0506	-5	5/16"	5/8" - 18 UNF	32.0	30.0	22
23.4S92.0606	-6	3/8"	5/8" - 18 UNF	34.0	30.0	22
23.4S92.1212	-12	3/4"	1.1/16" - 14 UNS	55.5	55.0	32

**MATERIAL:** Acero al carbono  
**ACABADO:** Enchapado sin cromo-(VI) / conforme a ROHS

**VERSIONES:** Acero inoxidable (agregue una 'S' al final de la REFERENCIA)

**NOTAS:** En tamaños más grandes, las tuercas pueden suministrarse con tuerca con seguro

# Macho SAE Cono Invertido 45°

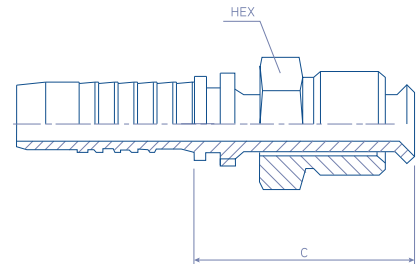

23.2210.

REFERENCIA	manguera tabla medidas	manguera Ø pulg.	Hilo	Corte C mm	HEX mm
23.2210.0404	04	1/4"	7/16" - 24UNS	42,0	11
23.2210.0405	04	1/4"	1/2" - 20UNF	47,0	13
23.2210.0406	04	1/4"	5/8" - 18UNF	46,0	16
23.2210.0604	04	3/8"	7/16" - 24UNS	42,0	11
23.2210.0605	06	3/8"	1/2" - 20UNF	44,0	13
23.2210.0606	06	3/8"	5/8" - 18UNF	46,0	16
23.2210.0808	08	1/2"	3/4" - 18UNS	47,0	19

**MATERIAL:** Acero al carbono

**ACABADO:** Enchapado sin cromo-(VI) / conforme a ROHS

**VERSIONES:** Acero inoxidable (agregue una 'S' al final de la REFERENCIA)



# Macho SAE Cono Invertido 45°, Codo 45°

23.2240.

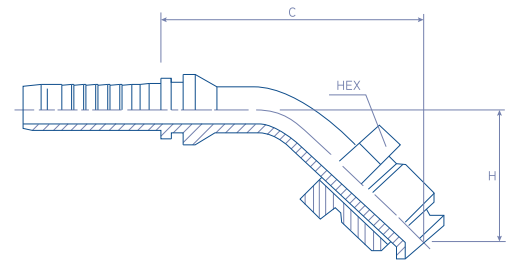

REFERENCIA	manguera tabla medidas	manguera Ø pulg.	Hilo	Corte C mm	H mm	HEX mm
23.2240.0404	04	1/4"	7/16" - 24UNS	36,0	16,0	11
23.2240.0405	04	1/4"	1/2" - 20UNF	40,0	18,0	13
23.2240.0604	04	3/8"	7/16" - 24UNS	36,0	16,0	11
23.2240.0605	06	3/8"	1/2" - 20UNF	37,0	18,0	13
23.2240.0606	06	3/8"	5/8" - 18UNF	48,0	22,0	16
23.2240.0808	08	1/2"	3/4" - 18UNS	50,0	26,0	19

**MATERIAL:** Acero al carbono

**ACABADO:** Enchapado sin cromo-(VI) / conforme a ROHS

**VERSIONES:** Acero inoxidable (agregue una 'S' al final de la REFERENCIA)

# Macho SAE Cono Invertido 45°, Codo 90°

23.2290.

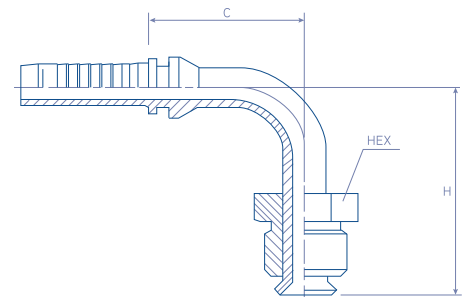

REFERENCIA	manguera tabla medidas	manguera Ø pulg.	Hilo	Corte C mm	H mm	HEX mm
23.2290.0404	04	1/4"	7/16" - 24UNS	36,0	40,0	11
23.2290.0405	04	1/4"	1/2" - 20UNF	42,0	40,0	13
23.2290.0406	04	1/4"	5/8" - 18UNF	40,0	40,0	16
23.2290.0604	04	3/8"	7/16" - 24UNS	37,0	40,0	11
23.2290.0605	06	3/8"	1/2" - 20UNF	40,0	40,0	13
23.2290.0606	06	3/8"	5/8" - 18UNF	40,0	40,0	16
23.2290.0808	08	1/2"	3/4" - 18UNS	40,0	46,0	19

**MATERIAL:** Acero al carbono

**ACABADO:** Enchapado sin cromo-(VI) / conforme a ROHS

**VERSIONES:** Acero inoxidable (agregue una 'S' al final de la REFERENCIA)

# Hilo NPTF Macho (AGN)

23.0400.

SAE J516 / SAE J476A

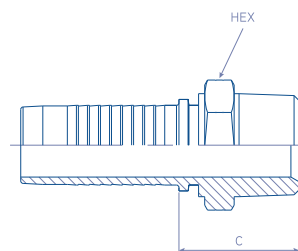

REFERENCIA	manguera	manguera Ø	hilo	Corte C	HEX
	tabla medidas	pulg.	pulg.	mm	mm
23.0400.0302	-3	3/16"	1/8" - 27	22.5	12
23.0400.0304	-3	3/16"	1/4" - 18	28.0	14
23.0400.0402	-4	1/4"	1/8" - 27	21.7	12
23.0400.0404	-4	1/4"	1/4" - 18	27.7	14
23.0400.0406	-4	1/4"	3/8" - 18	28.7	17
23.0400.0408	-4	1/4"	1/2" - 14	34.2	22
23.0400.0504	-5	5/16"	1/4" - 18	28.0	17
23.0400.0506	-5	5/16"	3/8" - 18	30.5	19
23.0400.0604	-6	3/8"	1/4" - 18	28.0	17
23.0400.0606	-6	3/8"	3/8" - 18	30.5	19
23.0400.0608	-6	3/8"	1/2" - 14	34.5	22
23.0400.0806	-8	1/2"	3/8" - 18	31.0	19
23.0400.0808	-8	1/2"	1/2" - 14	35.0	22
23.0400.0812	-8	1/2"	3/4" - 14	37.5	27
23.0400.1008	-10	5/8"	1/2" - 14	36.0	24
23.0400.1012	-10	5/8"	3/4" - 14	39.0	27
23.0400.1208	-12	3/4"	1/2" - 14	38.2	27
23.0400.1212	-12	3/4"	3/4" - 14	38.7	27
23.0400.1216	-12	3/4"	1" - 11.1/2	47.2	36
23.0400.1612	-16	1"	3/4" - 14	41.5	35
23.0400.1616	-16	1"	1" - 11.1/2	48.5	36
23.0400.1620	-16	1"	1.1/4" - 11.1/2	52.0	46
23.0400.2020	-20	1.1/4"	1.1/4" - 11.1/2	53.5	46
23.0400.2024	-20	1.1/4"	1.1/2" - 11.1/2	55.5	50
23.0400.2424	-24	1.1/2"	1.1/2" - 11.1/2	53.0	50
23.0400.2432	-24	1.1/2"	2" - 11.1/2	58.5	65
23.0400.3232	-32	2"	2" - 11.1/2	58.5	65

**MATERIAL:** Acero al carbono

**ACABADO:** Enchapado sin cromo-(VI) / conforme a ROHS

**VERSIONES:** Acero inoxidable (agregue una 'S' al final de la REFERENCIA)



# Hilo NPSM Hembra Giratoria

23.3010.

SAE J516 / SAE J514

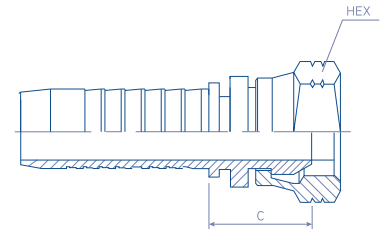

REFERENCIA	manguera tabla medidas	manguera Ø pulg.	Hilo	Corte C mm	HEX mm
23.3010.0402	04	1/4"	1/8"-27	23,7	14
23.3010.0404	04	1/4"	1/4"-18	26,7	19
23.3010.0406	04	1/4"	3/8"-18	29,1	22
23.3010.0606	06	3/8"	3/8"-18	27,2	22
23.3010.0608	06	3/8"	1/2"-14	29,0	27
23.3010.0808	08	1/2"	1/2"-14	30,7	27
23.3010.1212	12	3/4"	3/4"-14	35,3	32
23.3010.1616	16	1"	1"-11.5	38,0	41

**MATERIAL:** Acero al carbono

**ACABADO:** Enchapado sin cromo-(VI) / conforme a ROHS

**VERSIONES:** Acero inoxidable (agregue una 'S' al final de la REFERENCIA)

# Hilo Cónico BSPT Macho (AGR-K)

23.0300.

BS 5200

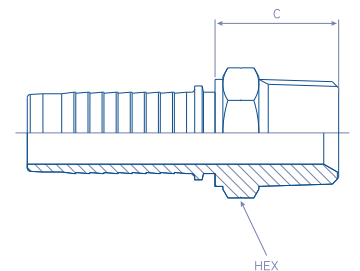

REFERENCIA	manguera tabla medidas	manguera Ø pulg.	hilo pulg.	Corte C mm	HEX mm
23.0300.0302	-3	3/16"	1/8" - 28	22.5	12
23.0300.0304	-3	3/16"	1/4" - 19	27.5	14
23.0300.0402	-4	1/4"	1/8" - 28	21.7	12
23.0300.0404	-4	1/4"	1/4" - 19	26.7	14
23.0300.0406	-4	1/4"	3/8" - 19	27.7	17
23.0300.0606	-6	3/8"	3/8" - 19	30.5	19
23.0300.0608	-6	3/8"	1/2" - 14	34.5	22
23.0300.0808	-8	1/2"	1/2" - 14	35.0	22
23.0300.1212	-12	3/4"	3/4" - 14	38.7	27
23.0300.1616	-16	1"	1" - 14	48.0	36
23.0300.2020	-20	1.1/4"	1.1/4" - 11	53.0	46
23.0300.2424	-24	1.1/2"	1.1/2" - 11	54.5	50
23.0300.3232	-32	2"	2" - 11	61.0	65

**MATERIAL:** Acero al carbono

**ACABADO:** Enchapado sin cromo-(VI) / conforme a ROHS

**VERSIONES:** Acero inoxidable (agregue una 'S' al final de la REFERENCIA)

# Macho ORFS

23.4000.

ISO 12151-1 / ISO 8434-3 / SAE J516

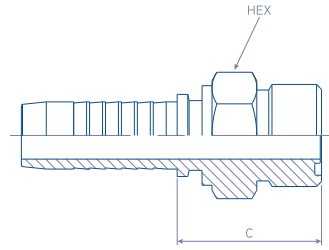

REFERENCIA	manguera	manguera Ø	hilo	Corte C	HEX
	tabla medidas	pulg.	pulg.	mm	mm
23.4000.0404	-4	1/4"	9/16" - 18	22.5	17
23.4000.0406	-4	1/4"	11/16" - 16	24.9	19
23.4000.0506	-5	5/16"	11/16" - 16	25.2	19
23.4000.0606	-6	3/8"	11/16" - 16	25.2	19
23.4000.0608	-6	3/8"	13/16" - 16	28.0	22
23.4000.0808	-8	1/2"	13/16" - 16	28.8	22
23.4000.0810	-8	1/2"	1" - 14	33.0	27
23.4000.0812	-8	1/2"	1.3/16" - 14	37.0	32
23.4000.1010	-10	5/8"	1" - 14	34.0	27
23.4000.1012	-10	5/8"	1.3/16" - 14	37.5	32
23.4000.1212	-12	3/4"	1.3/16" - 14	37.7	32
23.4000.1216	-12	3/4"	1.7/16" - 12	40.7	41
23.4000.1616	-16	1"	1.7/16" - 12	42.5	41
23.4000.2020	-20	1.1/4"	1.11/16" - 12	44.5	46
23.4000.2424	-24	1.1/2"	2" - 12	46.5	55

**MATERIAL:** Acero al carbono

**ACABADO:** Enchapado sin cromo-(VI) / conforme a ROHS

**VERSIONES:** Acero inoxidable (agregue una 'S' al final de la REFERENCIA)



# Hembra Giratoria ORFS

23.4414.

ISO 12151-1 / ISO 8434-3 / SAE J516

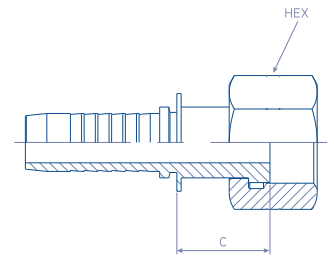

REFERENCIA	manguera	manguera Ø	hilo	Corte C	HEX
	tabla medidas	pulg.	pulg.	mm	mm
23.4414.0404	-4	1/4"	9/16" - 18	20.0	17
23.4414.0406	-4	1/4"	11/16" - 16	23.2	22
23.4414.0506	-5	5/16"	11/16" - 16	23.5	22
23.4414.0606	-6	3/8"	11/16" - 16	24.5	22
23.4414.0608	-6	3/8"	13/16" - 16	25.0	24
23.4414.0808	-8	1/2"	13/16" - 16	26.5	24
23.4414.0810	-8	1/2"	1" - 14	29.5	30
23.4414.0812	-8	1/2"	1.3/16" - 14	30.5	36
23.4414.1008	-10	5/8"	13/16" - 16	29.0	24
23.4414.1010	-10	5/8"	1" - 14	30.9	30
23.4414.1012	-10	5/8"	1.3/16" - 14	30.6	36
23.4414.1210	-12	3/4"	1" - 14	33.2	30
23.4414.1212	-12	3/4"	1.3/16" - 14	31.7	36
23.4414.1216	-12	3/4"	1.7/16" - 12	34.7	41
23.4414.1616	-16	1"	1.7/16" - 12	34.1	41
23.4414.1620	-16	1"	1.11/16" - 12	34.0	50
23.4414.2020	-20	1.1/4"	1.11/16" - 12	36.5	50
23.4414.2024	-20	1.1/4"	2" - 12	36.5	50
23.4414.2424	-24	1.1/2"	2" - 12	36.0	60

**MATERIAL:** Acero al carbono

**ACABADO:** Enchapado sin cromo-(VI) / conforme a ROHS

**VERSIONES:** Acero inoxidable (agregue una 'S' al final de la REFERENCIA)

# Hembra Giratoria ORFS con Hexágono Trasero

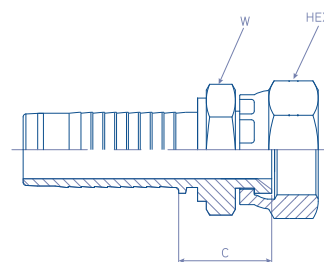

23.44H4.

ISO 12151-1 / ISO 8434-3 / SAE J516

REFERENCIA	manguera tabla medidas	manguera Ø pulg.	hilo pulg.	Corte C mm	W mm	HEX mm
23.44H4.0404	-4	1/4"	9/16" - 18	28.2	14	17
23.44H4.0406	-4	1/4"	11/16" - 16	31.7	17	22
23.44H4.0606	-6	3/8"	11/16" - 16	32.0	17	22
23.44H4.0608	-6	3/8"	13/16" - 16	35.0	19	24
23.44H4.0808	-8	1/2"	13/16" - 16	35.5	19	24
23.44H4.0810	-8	1/2"	1" - 14	41.5	24	30
23.44H4.0812	-8	1/2"	1.3/16" - 14	44.5	30	36
23.44H4.1010	-10	5/8"	1" - 14	42.5	24	30
23.44H4.1012	-10	5/8"	1.3/16" - 14	45.0	28	36
23.44H4.1212	-12	3/4"	1.3/16" - 14	45.6	30	36
23.44H4.1216	-12	3/4"	1.7/16" - 12	50.2	35	41
23.44H4.1616	-16	1"	1.7/16" - 12	50.7	35	41
23.44H4.1620	-16	1"	1.11/16" - 12	52.0	35	50
23.44H4.2020	-20	1.1/4"	1.11/16" - 12	54.5	41	50
23.44H4.2424	-24	1.1/2"	2" - 12	57.0	50	60

**MATERIAL:** Acero al carbono

**ACABADO:** Enchapado sin cromo-(VI) / conforme a ROHS

**VERSIONES:** Acero inoxidable (agregue una 'S' al final de la REFERENCIA)



# Hembra Giratoria ORFS, Codo 45°

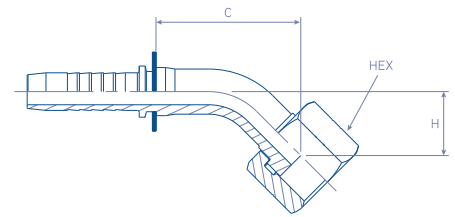

23.4444.

ISO 12151-5 / ISO 8434-2 / SAE J516 / SAE J514

REFERENCIA	manguera tabla medidas	manguera Ø pulg.	hilo pulg.	Corte C mm	H mm	HEX mm
23.4444.0404	-4	1/4"	9/16" - 18	32.5	11.0	17
23.4444.0406	-4	1/4"	11/16" - 16	36.0	13.0	22
23.4444.0506	-5	5/16"	11/16" - 16	39.0	13.0	22
23.4444.0606	-6	3/8"	11/16" - 16	36.0	13.4	22
23.4444.0608	-6	3/8"	13/16" - 16	39.0	15.0	24
23.4444.0808	-8	1/2"	13/16" - 16	43.0	15.0	24
23.4444.0810	-8	1/2"	1" - 14	45.0	17.0	30
23.4444.0812	-8	1/2"	1.3/16" - 14	54.0	21.0	36
23.4444.1008	-10	5/8"	13/16" - 16	54.0	22.0	24
23.4444.1010	-10	5/8"	1" - 14	55.0	21.0	30
23.4444.1012	-10	5/8"	1.3/16" - 14	57.0	23.0	36
23.4444.1210	-12	3/4"	1" - 14	60.0	23.0	30
23.4444.1212	-12	3/4"	1.3/16" - 14	62.0	22.0	36
23.4444.1216	-12	3/4"	1.7/16" - 12	66.0	24.0	41
23.4444.1616	-16	1"	1.7/16" - 12	76.0	27.0	41
23.4444.1620	-16	1"	1.11/16" - 12	76.0	27.0	50
23.4444.2020	-20	1.1/4"	1.11/16" - 12	95.0	34.0	50
23.4444.2424	-24	1.1/2"	2" - 12	120.0	45.0	60

**MATERIAL:** Acero al carbono

**ACABADO:** Enchapado sin cromo-(VI) / conforme a ROHS

**VERSIONES:** Acero inoxidable (agregue una 'S' al final de la REFERENCIA)

# Hembra Giratoria ORFS, Codo 90°

23.4494.

ISO 12151-5 / ISO 8434-2 / SAE J516 / SAE J514

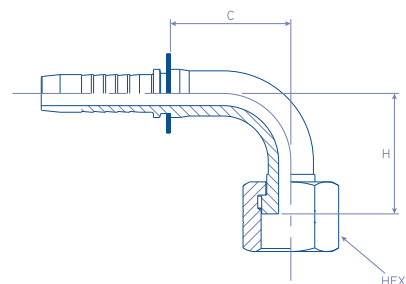

REFERENCIA	manguera tabla medidas	manguera Ø pulg.	hilo pulg.	Corte C mm	H mm	HEX mm
23.4494.0404	-4	1/4"	9/16" - 18	26.0	21.0	17
23.4494.0406	-4	1/4"	11/16" - 16	27.0	25.0	22
23.4494.0506	-5	5/16"	11/16" - 16	33.0	27.5	22
23.4494.0606	-6	3/8"	11/16" - 16	34.5	29.0	22
23.4494.0608	-6	3/8"	13/16" - 16	35.5	30.0	24
23.4494.0808	-8	1/2"	13/16" - 16	40.0	35.0	24
23.4494.0810	-8	1/2"	1" - 14	40.5	36.5	30
23.4494.0812	-8	1/2"	1.3/16" - 14	42.0	43.0	36
23.4494.1008	-10	5/8"	13/16" - 16	42.0	46.0	24
23.4494.1010	-10	5/8"	1" - 14	54.0	50.0	30
23.4494.1012	-10	5/8"	1.3/16" - 14	53.0	48.0	36
23.4494.1210	-12	3/4"	1" - 14	55.0	50.0	30
23.4494.1212	-12	3/4"	1.3/16" - 14	57.0	49.0	36
23.4494.1216	-12	3/4"	1.7/16" - 12	57.0	52.0	41
23.4494.1616	-16	1"	1.7/16" - 12	68.0	59.0	41
23.4494.1620	-16	1"	1.11/16" - 12	68.0	77.0	50
23.4494.2020	-20	1.1/4"	1.11/16" - 12	85.0	77.0	50
23.4494.2424	-24	1.1/2"	2" - 12	98.0	94.0	60

**MATERIAL:** Acero al carbono

**ACABADO:** Enchapado sin cromo-(VI) / conforme a ROHS

**VERSIONES:** Acero inoxidable (agregue una 'S' al final de la REFERENCIA)



# Flange SAE Recto (código 61) 3000 PSI (SFL)

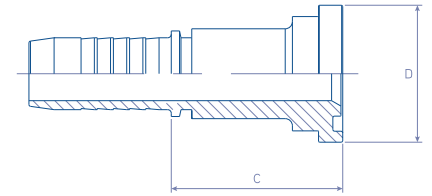

23.7013.

ISO 6162-1 / ISO 12151-3 / SAE J516 / SAE J518

REFERENCIA	manguera	manguera Ø	D Ø Flange	C Corte
	tabla medidas	pulg.	mm	mm
23.7013.0808	-8	1/2"	30.2	40.0
23.7013.0812	-8	1/2"	38.1	42.0
23.7013.1010	-10	5/8"	34.0	37.0
23.7013.1012	-10	5/8"	38.1	45.0
23.7013.1212	-12	3/4"	38.1	45.0
23.7013.1216	-12	3/4"	44.5	48.0
23.7013.1616	-16	1"	44.5	50.0
23.7013.1620	-16	1"	50.8	54.0
23.7013.2020	-20	1 1/4"	50.8	55.0
23.7013.2024	-20	1 1/4"	60.3	60.0
23.7013.2424	-24	1 1/2"	60.3	60.0
23.7013.2432	-24	1 1/2"	71.4	65.0
23.7013.3232	-32	2"	71.4	66.0
23.7013.4040	-40	2 1/2"	84.1	90.0
23.7013.4848	-48	3"	101.6	91.0

**MATERIAL:** Acero al carbono  
**ACABADO:** Enchapado sin cromo-(VI) / conforme a ROHS

**VERSIONES:** Acero inoxidable (agregue una 'S' al final de la REFERENCIA)

**NOTAS:** Si bien no forma parte de la norma SAE o ISO, el tamaño 34.0mm (5/8) cumple la norma JIS

# Flange SAE (código 61) 3000 PSI, Codo 45° (SFL 45°)

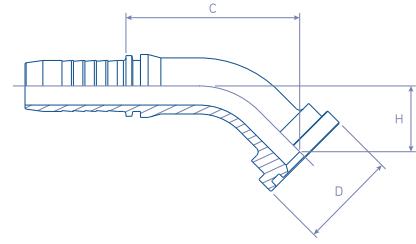

23.7043.

ISO 6162-1 / ISO 12151-3 / SAE J516 / SAE J518

REFERENCIA	manguera tabla medidas	manguera Ø pulg.	D Ø Flange mm	Corte C mm	H mm
23.7043.0808	-8	1/2"	30.2	57.0	23.0
23.7043.0812	-8	1/2"	38.1	63.0	28.0
23.7043.1010	-10	5/8"	34.0	67.0	28.0
23.7043.1012	-10	5/8"	38.1	68.0	28.0
23.7043.1212	-12	3/4"	38.1	69.0	28.0
23.7043.1216	-12	3/4"	44.5	75.0	32.0
23.7043.1616	-16	1"	44.5	76.0	31.0
23.7043.1620	-16	1"	50.8	85.0	35.0
23.7043.2020	-20	1.1/4"	50.8	95.0	36.0
23.7043.2024	-20	1.1/4"	60.3	100.0	38.0
23.7043.2424	-24	1.1/2"	60.3	100.0	40.0
23.7043.2432	-24	1.1/2"	71.4	110.0	42.0
23.7043.3232	-32	2"	71.4	145.0	56.0
23.7043.4040	-40	2.1/2"	84.1	135.0	58.0
23.7043.4848	-48	3"	101.6	136.0	58.0

**MATERIAL:** Acero al carbono  
**ACABADO:** Enchapado sin cromo-(VI) / conforme a ROHS

**VERSIONES:** Acero inoxidable (agregue una 'S' al final de la REFERENCIA)

**NOTAS:** Si bien no forma parte de la norma SAE o ISO, el tamaño 34.0mm (5/8) cumple la norma JIS



# Flange SAE (código 61) 3000 PSI, Codo 90° (SFL 90°)

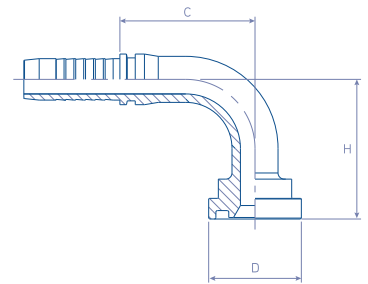

23.7093.

ISO 6162-1 / ISO 12151-3 / SAE J516 / SAE J518

REFERENCIA	manguera	manguera Ø	D Ø Flange	Corte C	H
	tabla medidas	pulg.	mm	mm	mm
23.7093.0808	-8	1/2"	30.2	46.5	45.0
23.7093.0812	-8	1/2"	38.1	49.0	49.5
23.7093.1010	-10	5/8"	34.0	55.5	55.0
23.7093.1012	-10	5/8"	38.1	55.5	56.5
23.7093.1212	-12	3/4"	38.1	55.5	58.0
23.7093.1216	-12	3/4"	44.5	70.0	61.0
23.7093.1616	-16	1"	44.5	69.9	61.0
23.7093.1620	-16	1"	50.8	88.0	83.0
23.7093.2020	-20	1 1/4"	50.8	88.0	93.0
23.7093.2024	-20	1 1/4"	60.3	95.0	98.0
23.7093.2424	-24	1 1/2"	60.3	100.0	110.0
23.7093.2432	-24	1 1/2"	71.4	130.0	110.0
23.7093.3232	-32	2"	71.4	136.2	125.0
23.7093.4040	-40	2 1/2"	84.1	132.7	114.2
23.7093.4848	-48	3"	101.6	60.5	55.0

**MATERIAL:** Acero al carbono  
**ACABADO:** Enchapado sin cromo-(VI) / conforme a ROHS

**VERSIONES:** Acero inoxidable (agregue una 'S' al final de la REFERENCIA)

**NOTAS:** Si bien no forma parte de la norma SAE o ISO, el tamaño 34.0mm (5/8) cumple la norma JIS

# Flange SAE Recta (código 62) 6000 PSI (SFS)

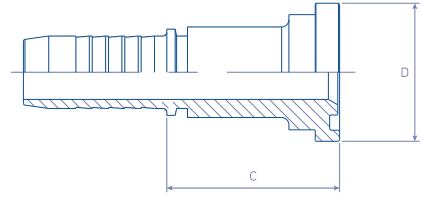

23.7016.

ISO 6162-2 / ISO 12151-3 / SAE J516 / SAE J518

REFERENCIA	manguera	manguera Ø	D Ø Flange	Corte C
	tabla medidas	pulg.	mm	mm
23.7016.0808	-8	1/2"	31.8	46.0
23.7016.0812	-8	1/2"	31.8	46.0
23.7016.1012	-10	5/8"	41.3	46.0
23.7016.1212	-12	3/4"	41.3	46.0
23.7016.1216	-12	3/4"	47.6	56.0
23.7016.1616	-16	1"	47.6	57.0
23.7016.1620	-16	1"	54.0	65.0
23.7016.2020	-20	1,1/4"	54.0	66.0
23.7016.2024	-20	1,1/4"	63.5	75.0
23.7016.2424	-24	1,1/2"	63.5	75.0
23.7016.2432	-24	1,1/2"	79.4	80.0
23.7016.3232	-32	2"	79.4	85.0

**MATERIAL:** Acero al carbono

**ACABADO:** Enchapado sin cromo-(VI) / conforme a ROHS

**VERSIONES:** Acero inoxidable (agregue una 'S' al final de la REFERENCIA)



# Flange SAE (código 62) 6000 PSI, Codo 45° (SFS 45°)

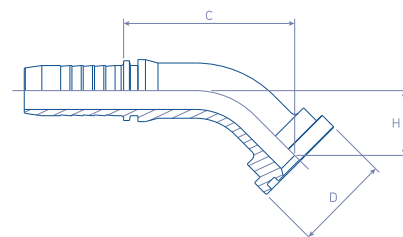

23.7046.

ISO 6162-1 / ISO 12151-3 / SAE J516 / SAE J518

REFERENCIA	manguera	manguera Ø	D Ø Flange	Corte C	H
	tabla medidas	pulg.	mm	mm	mm
23.7046.0808	-8	1/2"	31.8	57.0	23.0
23.7046.0812	-8	1/2"	31.8	63.0	30.0
23.7046.1012	-10	5/8"	41.3	68.0	28.0
23.7046.1212	-12	3/4"	41.3	69.0	28.0
23.7046.1216	-12	3/4"	47.6	77.0	33.0
23.7046.1616	-16	1"	47.6	79.0	32.0
23.7046.1620	-16	1"	54.0	93.0	38.0
23.7046.2020	-20	1 1/4"	54.0	110.0	44.0
23.7046.2024	-20	1 1/4"	63.5	112.0	48.0
23.7046.2424	-24	1 1/2"	63.5	110.0	46.0
23.7046.2432	-24	1 1/2"	79.4	134.0	58.0
23.7046.3232	-32	2"	79.4	155.0	64.0

**MATERIAL:** Acero al carbono

**ACABADO:** Enchapado sin cromo-(VI) / conforme a ROHS

**VERSIONES:** Acero inoxidable (agregue una 'S' al final de la REFERENCIA)

# Flange SAE (código 62) 6000 PSI, Codo 90° (SFS 90°)

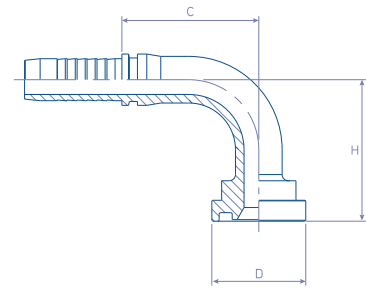

23.7096.

ISO 6162-1 / ISO 12151-3 / SAE J516 / SAE J518

REFERENCIA	manguera tabla medidas	manguera Ø pulg.	D Ø Flange mm	Corte C mm	H mm
23.7096.0808	-8	1/2"	31.8	46.5	47.0
23.7096.0812	-8	1/2"	31.8	50.5	56.0
23.7096.1012	-10	5/8"	41.3	53.5	58.0
23.7096.1212	-12	3/4"	41.3	55.5	56.5
23.7096.1216	-12	3/4"	47.6	55.5	65.0
23.7096.1616	-16	1"	47.6	76.0	66.0
23.7096.1620	-16	1"	54.0	78.5	79.5
23.7096.2020	-20	1,1/4"	54.0	101.7	86.0
23.7096.2024	-20	1,1/4"	63.5	102.3	98.0
23.7096.2424	-24	1,1/2"	63.5	111.0	104.0
23.7096.2432	-24	1,1/2"	79.4	113.0	119.5
23.7096.3232	-32	2"	79.4	149.3	134.0

**MATERIAL:** Acero al carbono

**ACABADO:** Enchapado sin cromo-(VI) / conforme a ROHS

**VERSIONES:** Acero inoxidable (agregue una 'S' al final de la REFERENCIA)



# Flange Recto SUPERCAT

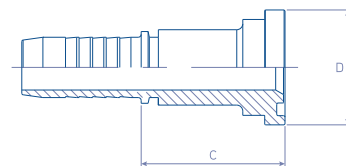

23.7116.

ISO 6162-2 / ISO 12151-3 / SAE J516 / SAE J518

REFERENCIA	manguera	manguera Ø	D Ø Flange	Corte C
	tabla medidas	pulg.	mm	mm
23.7116.0808	-8	1/2"	31.8	46.0
23.7116.0812	-8	1/2"	31.8	46.0
23.7116.1012	-10	5/8"	41.3	46.0
23.7116.1212	-12	3/4"	41.3	46.0
23.7116.1216	-12	3/4"	47.6	56.0
23.7116.1616	-16	1"	47.6	57.0
23.7116.1620	-16	1"	54.0	65.0
23.7116.2020	-20	1.1/4"	54.0	66.0
23.7116.2024	-20	1.1/4"	63.5	75.0
23.7116.2424	-24	1.1/2"	63.5	75.0
23.7116.2432	-24	1.1/2"	79.4	80.0
23.7116.3232	-32	2"	79.4	85.0

**MATERIAL:** Acero al carbono

**ACABADO:** Enchapado sin cromo-(VI) / conforme a ROHS

**VERSIONES:** Acero inoxidable (agregue una 'S' al final de la REFERENCIA)

# Flange SUPERCAT, Codo 45°

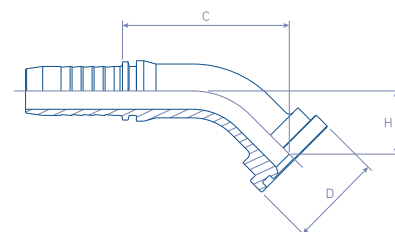

23.7146.

ISO 6162-1 / ISO 12151-3 / SAE J516 / SAE J518

REFERENCIA	manguera	manguera Ø	D Ø Flange	Corte C	H
	tabla medidas	pulg.	mm	mm	mm
23.7146.0808	-8	1/2"	31.8	57.0	23.0
23.7146.0812	-8	1/2"	31.8	63.0	30.0
23.7146.1012	-10	5/8"	41.3	68.0	28.0
23.7146.1212	-12	3/4"	41.3	69.0	28.0
23.7146.1216	-12	3/4"	47.6	77.0	33.0
23.7146.1616	-16	1"	47.6	79.0	32.0
23.7146.1620	-16	1"	54.0	93.0	38.0
23.7146.2020	-20	1.1/4"	54.0	110.0	44.0
23.7146.2024	-20	1.1/4"	63.5	112.0	48.0
23.7146.2424	-24	1.1/2"	63.5	110.0	46.0
23.7146.2432	-24	1.1/2"	79.4	134.0	58.0
23.7146.3232	-32	2"	79.4	155.0	64.0

**MATERIAL:** Acero al carbono

**ACABADO:** Enchapado sin cromo-(VI) / conforme a ROHS

**VERSIONES:** Acero inoxidable (agregue una 'S' al final de la REFERENCIA)

# Flange SUPERCAT, Codo 90°

23.7196.

ISO 6162-1 / ISO 12151-3 / SAE J516 / SAE J518

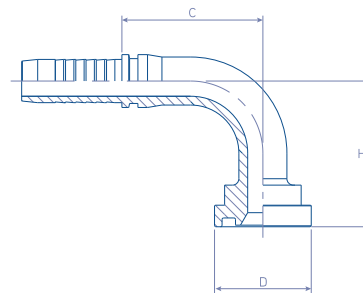

REFERENCIA	manguera tabla medidas	manguera Ø pulg.	D Ø Flange mm	Corte C mm	H mm
23.7196.0808	-8	1/2"	31.8	46.5	47.0
23.7196.0812	-8	1/2"	31.8	50.5	56.0
23.7196.1012	-10	5/8"	41.3	53.5	58.0
23.7196.1212	-12	3/4"	41.3	55.5	56.5
23.7196.1216	-12	3/4"	47.6	55.5	65.0
23.7196.1616	-16	1"	47.6	76.0	66.0
23.7196.1620	-16	1"	54.0	78.5	79.5
23.7196.2020	-20	1.1/4"	54.0	101.7	86.0
23.7196.2024	-20	1.1/4"	63.5	102.3	98.0
23.7196.2424	-24	1.1/2"	63.5	111.0	104.0
23.7196.2432	-24	1.1/2"	79.4	113.0	119.5
23.7196.3232	-32	2"	79.4	149.3	134.0

**MATERIAL:** Acero al carbono

**ACABADO:** Enchapado sin cromo-(VI) / conforme a ROHS

**VERSIONES:** Acero inoxidable (agregue una 'S' al final de la REFERENCIA)

# Hembra Giratoria BSP Cara Plana

23.3212.

ISO 12151-6 / ISO 8434-6 / BS 5200

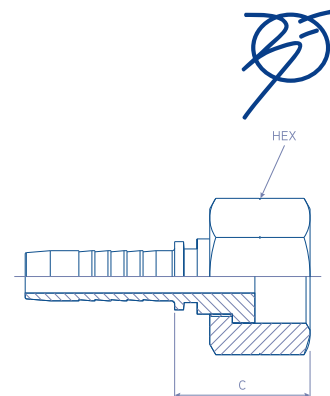

REFERENCIA	manguera tabla medidas	manguera Ø pulg.	hilo pulg.	Corte C mm	HEX mm
23.3212.0404	-4	1/4"	1/8" - 28	15.2	19
23.3212.0508	-5	5/16"	1/2" - 14	18.0	27
23.3212.0606	-6	3/8"	3/8" - 19	16.5	22
23.3212.0608	-6	3/8"	1/2" - 14	18.0	27
23.3212.0808	-8	1/2"	1/2" - 14	18.5	27
23.3212.0812	-8	1/2"	3/4" - 14	20.5	32
23.3212.1012	-10	5/8"	3/4" - 14	21.0	32
23.3212.1212	-12	3/4"	3/4" - 14	21.2	32
23.3212.1216	-12	3/4"	1" - 11	21.7	38
23.3212.1616	-16	1"	1" - 11	22.5	38

**MATERIAL:** Acero al carbono

**ACABADO:** Enchapado sin cromo-(VI) / conforme a ROHS

**VERSIONES:** Acero inoxidable (agregue una 'S' al final de la REFERENCIA)

# Macho Métrico Serie Ligera Asiento Cono 24° (CEL)

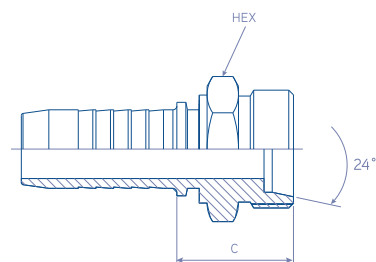

23.1000.

ISO 12151-2 / ISO 8434-1

REFERENCIA	manguera tabla medidas	manguera Ø pulg.	hilo pulg.	d-tubo mm	C corte mm	HEX mm
23.1000.0312	-3	3/16"	M12 x 1.5	6	23.0	14
23.1000.0412	-4	1/4"	M12 x 1.5	6	22.2	14
23.1000.0414	-4	1/4"	M14 x 1.5	8	22.7	17
23.1000.0416	-4	1/4"	M16 x 1.5	10	23.7	17
23.1000.0418	-4	1/4"	M18 x 1.5	12	24.7	19
23.1000.0514	-5	5/16"	M14 x 1.5	8	23.0	17
23.1000.0516	-5	5/16"	M16 x 1.5	10	24.0	17
23.1000.0518	-5	5/16"	M18 x 1.5	12	25.0	19
23.1000.0616	-6	3/8"	M16 x 1.5	10	24.0	17
23.1000.0618	-6	3/8"	M18 x 1.5	12	25.0	19
23.1000.0622	-6	3/8"	M22 x 1.5	15	28.0	24
23.1000.0818	-8	1/2"	M18 x 1.5	12	25.5	19
23.1000.0822	-8	1/2"	M22 x 1.5	15	28.5	24
23.1000.0826	-8	1/2"	M26 x 1.5	18	30.0	27
23.1000.1026	-10	5/8"	M26 x 1.5	18	30.0	27
23.1000.1030	-10	5/8"	M30 x 2.0	22	34.0	32
23.1000.1230	-12	3/4"	M30 x 2.0	22	34.2	32
23.1000.1636	-16	1"	M36 x 2.0	28	38.0	41
23.1000.2045	-20	1.1/4"	M45 x 2.0	35	43.0	46
23.1000.2452	-24	1.1/2"	M52 x 2.0	42	45.0	55

**MATERIAL:** Acero al carbono

**ACABADO:** Enchapado sin cromo-(VI) / conforme a ROHS

**VERSIONES:** Acero inoxidable (agregue una 'S' al final de la REFERENCIA)



# Hembra Métrica Giratoria Serie Ligera Asiento Cono 24° (DKOL)

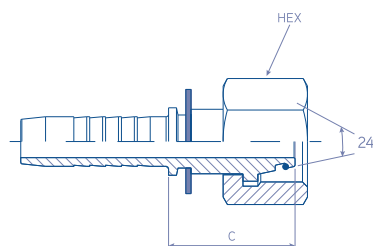

23.5013.

ISO 12151-2 / ISO 8434-1

REFERENCIA	manguera tabla medidas	manguera Ø pulg.	hilo pulg.	d tubo mm	C corte mm	HEX mm
23.5013.0312	-3	3/16"	M12 x 1.5	6	22.5	14
23.5013.0412	-4	1/4"	M12 x 1.5	6	26.7	14
23.5013.0414	-4	1/4"	M14 x 1.5	8	25.7	17
23.5013.0416	-4	1/4"	M16 x 1.5	10	21.8	19
23.5013.0418	-4	1/4"	M18 x 1.5	12	25.2	22
23.5013.0514	-5	5/16"	M14 x 1.5	8	27.5	19
23.5013.0516	-5	5/16"	M16 x 1.5	10	22.1	19
23.5013.0518	-5	5/16"	M18 x 1.5	12	25.5	22
23.5013.0616	-6	3/8"	M16 x 1.5	10	28.5	19
23.5013.0618	-6	3/8"	M18 x 1.5	12	24.6	22
23.5013.0622	-6	3/8"	M22 x 1.5	15	27.5	27
23.5013.0818	-8	1/2"	M18 x 1.5	12	30.5	22
23.5013.0822	-8	1/2"	M22 x 1.5	15	28.0	27
23.5013.0826	-8	1/2"	M26 x 1.5	18	26.8	32
23.5013.1026	-10	5/8"	M26 x 1.5	18	29.0	32
23.5013.1027	-10	5/8"	M27 x 1.5	18	29.0	32
23.5013.1030	-10	5/8"	M30 x 2.0	22	32.0	36
23.5013.1230	-12	3/4"	M30 x 2.0	22	34.7	36
23.5013.1636	-16	1"	M36 x 2.0	28	33.5	41
23.5013.2045	-20	1.1/4"	M45 x 2.0	35	38.5	50
23.5013.2452	-24	1.1/2"	M52 x 2.0	42	39.5	60

**MATERIAL:** Acero al carbono

**ACABADO:** Enchapado sin cromo-(VI) / conforme a ROHS

**VERSIONES:** Acero inoxidable (agregue una 'S' al final de la REFERENCIA)

# Hembra Métrica Giratoria Serie Ligera Asiento Cono 24°, Codo 45° (DKOL 45)

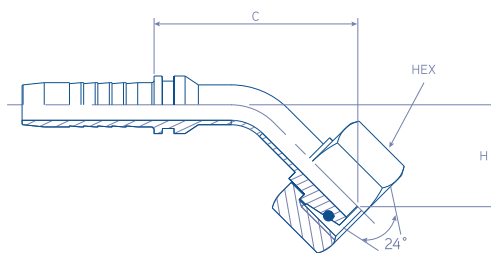

23.5043.

ISO 12151-2 / ISO 8434-1

REFERENCIA	manguera tabla medidas	manguera Ø pulg.	hilo pulg.	d tubo mm	Corte C mm	H mm	HEX mm
23.5043.0312	-3	3/16"	M12 x 1.5	6	38.0	15.0	14
23.5043.0412	-4	1/4"	M12 x 1.5	6	39.0	15.0	14
23.5043.0414	-4	1/4"	M14 x 1.5	8	35.2	16.0	17
23.5043.0416	-4	1/4"	M16 x 1.5	10	36.3	17.0	19
23.5043.0418	-4	1/4"	M18 x 1.5	12	40.0	18.5	22
23.5043.0516	-5	5/16"	M16 x 1.5	10	39.0	17.0	19
23.5043.0518	-5	5/16"	M18 x 1.5	12	42.6	19.0	22
23.5043.0616	-6	3/8"	M16 x 1.5	10	54.8	20.0	19
23.5043.0618	-6	3/8"	M18 x 1.5	12	42.6	19.0	22
23.5043.0622	-6	3/8"	M22 x 1.5	15	45.0	19.0	27
23.5043.0822	-8	1/2"	M22 x 1.5	15	48.2	20.0	27
23.5043.0826	-8	1/2"	M26 x 1.5	18	49.9	21.0	32
23.5043.1026	-10	5/8"	M26 x 1.5	18	62.5	25.0	32
23.5043.1027	-10	5/8"	M27 x 1.5	18	62.5	25.0	32
23.5043.1030	-10	5/8"	M30 x 2.0	22	66.6	25.0	36
23.5043.1230	-12	3/4"	M30 x 2.0	22	78.0	30.0	36
23.5043.1636	-16	1"	M36 x 2.0	28	90.5	33.0	41
23.5043.2045	-20	1.1/4"	M45 x 2.0	35	102.5	40.0	50
23.5043.2452	-24	1.1/2"	M52 x 2.0	42	127.1	45.0	60

**MATERIAL:** Acero al carbono

**ACABADO:** Enchapado sin cromo-(VI) / conforme a ROHS

**VERSIONES:** Acero inoxidable (agregue una 'S' al final de la REFERENCIA)



# Hembra Métrica Serie Ligera Asiento Cono 24°, Codo 90° (DKOL 90)

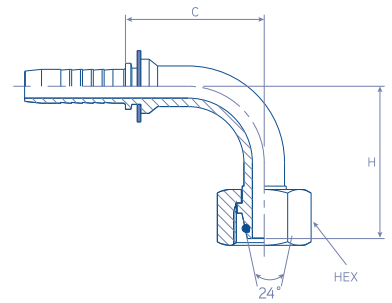

23.5093.

ISO 12151-2 / ISO 8434-1

REFERENCIA	manguera tabla medidas	manguera Ø pulg.	hilo pulg.	d tubo mm	Corte C mm	H mm	HEX mm
23.5093.0312	-3	3/16"	M12 x 1.5	6	30.0	30.0	14
23.5093.0412	-4	1/4"	M12 x 1.5	6	30.7	30.0	14
23.5093.0414	-4	1/4"	M14 x 1.5	8	28.0	30.5	17
23.5093.0416	-4	1/4"	M16 x 1.5	10	28.2	33.0	19
23.5093.0418	-4	1/4"	M18 x 1.5	12	35.0	36.0	22
23.5093.0516	-5	5/16"	M16 x 1.5	10	30.5	33.0	19
23.5093.0518	-5	5/16"	M18 x 1.5	12	36.0	36.0	22
23.5093.0616	-6	3/8"	M16 x 1.5	10	34.0	36.0	19
23.5093.0618	-6	3/8"	M18 x 1.5	12	36.0	36.0	22
23.5093.0622	-6	3/8"	M22 x 1.5	15	37.5	38.0	27
23.5093.0822	-8	1/2"	M22 x 1.5	15	38.2	40.5	27
23.5093.0826	-8	1/2"	M26 x 1.5	18	48.0	47.0	32
23.5093.1026	-10	5/8"	M26 x 1.5	18	54.0	52.0	32
23.5093.1027	-10	5/8"	M27 x 1.5	18	54.0	52.0	32
23.5093.1030	-10	5/8"	M30 x 2.0	22	55.5	57.0	36
23.5093.1230	-12	3/4"	M30 x 2.0	22	55.5	57.0	36
23.5093.1236	-12	3/4"	M36 x 2.0	28	55.5	57.0	41
23.5093.1636	-16	1"	M36 x 2.0	28	78.6	70.0	41
23.5093.2045	-20	1,1/4"	M45 x 2.0	35	85.5	80.0	50
23.5093.2452	-24	1,1/2"	M52 x 2.0	42	116.3	98.0	60

**MATERIAL:** Acero al carbono

**ACABADO:** Enchapado sin cromo-(VI) / conforme a ROHS

**VERSIONES:** Acero inoxidable (agregue una 'S' al final de la REFERENCIA)

# Macho Métrico Serie Pesada Asiento Cono 24° (CES)

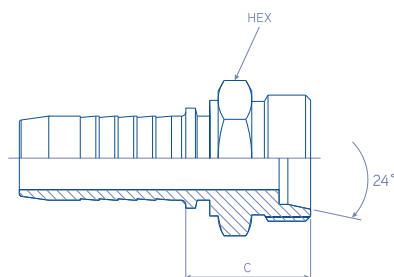

23.1100.

ISO 12151-2 / ISO 8434-1

REFERENCIA	manguera tabla medidas	manguera Ø pulg.	hilo pulg.	d-tubo mm	C corte mm	HEX mm
23.1100.0414	-4	1/4"	M14 x 1.5	6	24.7	17
23.1100.0416	-4	1/4"	M16 x 1.5	8	24.7	17
23.1100.0418	-4	1/4"	M18 x 1.5	10	25.7	19
23.1100.0516	-5	5/16"	M16 x 1.5	8	25.0	17
23.1100.0518	-5	5/16"	M18 x 1.5	10	26.0	19
23.1100.0520	-5	5/16"	M20 x 1.5	12	27.5	22
23.1100.0618	-6	3/8"	M18 x 1.5	10	26.0	19
23.1100.0620	-6	3/8"	M20 x 1.5	12	27.5	22
23.1100.0622	-6	3/8"	M22 x 1.5	14	30.0	24
23.1100.0820	-8	1/2"	M20 x 1.5	12	27.5	22
23.1100.0824	-8	1/2"	M24 x 1.5	16	32.0	27
23.1100.1024	-10	5/8"	M24 x 1.5	16	32.5	27
23.1100.1030	-10	5/8"	M30 x 2.0	20	36.0	32
23.1100.1230	-12	3/4"	M30 x 2.0	20	36.2	32
23.1100.1236	-12	3/4"	M36 x 2.0	25	41.2	41
23.1100.1636	-16	1"	M36 x 2.0	25	42.0	41
23.1100.1642	-16	1"	M42 x 2.0	30	45.5	46
23.1100.2052	-20	1.1/4"	M52 x 2.0	38	51.0	55
23.1100.2452	-24	1.1/2"	M52 x 2.0	38	51.0	55

**MATERIAL:** Acero al carbono

**ACABADO:** Enchapado sin cromo-(VI) / conforme a ROHS

**VERSIONES:** Acero inoxidable (agregue una 'S' al final de la REFERENCIA)



# Hembra Métrica Giratoria Serie Pesada Asiento Cono 24° (DKOS)

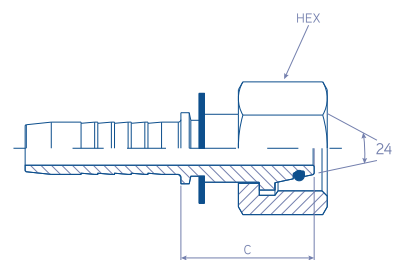

23.5113.

ISO 12151-2 / ISO 8434-1

REFERENCIA	manguera tabla medidas	manguera Ø pulg.	hilo pulg.	d-tubo mm	C corte mm	HEX mm
23.5113.0414	-4	1/4"	M14 x 1.5	6	26.2	17
23.5113.0416	-4	1/4"	M16 x 1.5	8	21.7	19
23.5113.0418	-4	1/4"	M18 x 1.5	10	26.2	22
23.5113.0518	-5	5/16"	M18 x 1.5	10	26.5	22
23.5113.0520	-5	5/16"	M20 x 1.5	12	27.5	24
23.5113.0618	-5	5/16"	M18 x 1.5	10	26.5	22
23.5113.0620	-5	5/16"	M20 x 1.5	12	27.5	24
23.5113.0622	-6	3/8"	M22 x 1.5	14	28.5	27
23.5113.0820	-8	1/2"	M20 x 1.5	12	29.0	24
23.5113.0822	-8	1/2"	M22 x 1.5	14	29.0	27
23.5113.0824	-8	1/2"	M24 x 1.5	16	28.5	30
23.5113.1030	-10	5/8"	M30 x 2.0	20	34.0	36
23.5113.1230	-12	3/4"	M30 x 2.0	20	35.7	36
23.5113.1236	-12	3/4"	M36 x 2.0	25	35.7	46
23.5113.1636	-16	1"	M36 x 2.0	25	36.5	46
23.5113.1642	-16	1"	M42 x 2.0	30	39.0	50
23.5113.2052	-20	1.1/4"	M52 x 2.0	30	46.0	50
23.5113.2452	-24	1.1/2"	M52 x 2.0	38	42.5	60

**MATERIAL:** Acero al carbono

**ACABADO:** Enchapado sin cromo-(VI) / conforme a ROHS

**VERSIONES:** Acero inoxidable (agregue una 'S' al final de la REFERENCIA)

# Hembra Métrica Giratoria Serie Pesada Asiento Cono 24°, Codo 45° (DKOS 45)

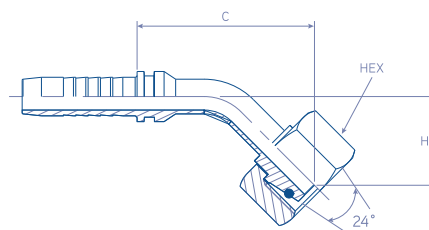

23.5143.

ISO 12151-2 / ISO 8434-1

REFERENCIA	manguera tabla medidas	manguera Ø pulg.	hilo pulg.	d tubo mm	Corte C mm	H mm	HEX mm
23.5143.0414	-4	1/4"	M14 x 1.5	6	35.2	16.0	17
23.5143.0416	-4	1/4"	M16 x 1.5	8	36.3	17.0	19
23.5143.0418	-4	1/4"	M18 x 1.5	10	37.7	17.0	22
23.5143.0518	-5	5/16"	M18 x 1.5	10	40.0	17.0	22
23.5143.0520	-5	5/16"	M20 x 1.5	12	41.0	18.0	24
23.5143.0618	-6	3/8"	M18 x 1.5	10	42.6	19.0	22
23.5143.0620	-6	3/8"	M20 x 1.5	12	42.0	18.0	24
23.5143.0622	-6	3/8"	M22 x 1.5	14	43.0	19.0	27
23.5143.0820	-8	1/2"	M20 x 1.5	12	48.2	20.0	24
23.5143.0824	-8	1/2"	M24 x 1.5	16	49.9	21.0	30
23.5143.1030	-10	5/8"	M30 x 2.0	20	66.6	25.0	36
23.5143.1230	-12	3/4"	M30 x 2.0	20	70.5	30.0	36
23.5143.1236	-12	3/4"	M36 x 2.0	25	84.0	30.5	46
23.5143.1636	-16	1"	M36 x 2.0	25	87.0	36.0	46
23.5143.1642	-16	1"	M42 x 2.0	30	89.0	38.0	50
23.5143.2052	-20	1.1/4"	M52 x 2.0	38	121.3	44.0	60

**MATERIAL:** Acero al carbono

**ACABADO:** Enchapado sin cromo-(VI) / conforme a ROHS

**VERSIONES:** Acero inoxidable (agregue una 'S' al final de la REFERENCIA)



# Hembra Métrica Giratoria Serie Pesada Asiento Cono 24°, Codo 90° (DKOS 90)

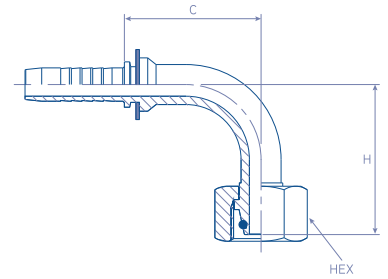

23.5193.

ISO 12151-2 / ISO 8434-1

REFERENCIA	manguera tabla medidas	manguera Ø pulg.	hilo pulg.	d tubo mm	Corte C mm	H mm	HEX mm
23.5193.0414	-4	1/4"	M14 x 1.5	6	27.0	30.5	17
23.5193.0416	-4	1/4"	M16 x 1.5	8	28.2	32.5	19
23.5193.0418	-4	1/4"	M18 x 1.5	10	28.2	34.5	22
23.5193.0518	-5	5/16"	M18 x 1.5	10	30.5	36.0	22
23.5193.0520	-5	5/16"	M20 x 1.5	12	30.5	36.0	24
23.5193.0618	-6	3/8"	M18 x 1.5	10	40.0	44.0	22
23.5193.0620	-6	3/8"	M20 x 1.5	12	30.5	36.0	24
23.5193.0622	-6	3/8"	M22 x 1.5	14	33.0	37.0	27
23.5193.0820	-8	1/2"	M20 x 1.5	12	35.0	38.0	24
23.5193.0824	-8	1/2"	M24 x 1.5	16	41.0	42.5	30
23.5193.1024	-10	5/8"	M24 x 1.5	16	55.5	57.5	30
23.5193.1030	-10	5/8"	M30 x 2.0	20	55.5	57.5	36
23.5193.1230	-12	3/4"	M30 x 2.0	20	55.5	57.0	36
23.5193.1236	-12	3/4"	M36 x 2.0	25	55.5	60.0	46
23.5193.1636	-16	1"	M36 x 2.0	25	74.0	71.5	46
23.5193.1642	-16	1"	M42 x 2.0	30	74.0	75.0	50
23.5193.2052	-20	1.1/4"	M52 x 2.0	38	89.0	87.0	60

**MATERIAL:** Acero al carbono

**ACABADO:** Enchapado sin cromo-(VI) / conforme a ROHS

**VERSIONES:** Acero inoxidable (agregue una 'S' al final de la REFERENCIA)

# Hembra Métrica Giratoria Asiento Cono 24°/60°C (DKL)

23.5213.  
DIN 3868

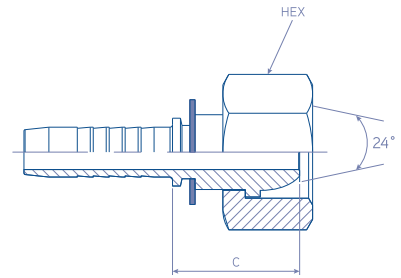

REFERENCIA	manguera tabla medidas	manguera Ø pulg.	hilo pulg.	d-tubo mm	C corte mm	HEX mm
23.5213.0414	- 4	1/4"	M14 x 1.5	8	25.7	17
23.5213.0516	- 5	5/16"	M16 x 1.5	10	22.1	19
23.5213.0518	- 5	5/16"	M18 x 1.5	12	25.5	22
23.5213.0616	- 6	3/8"	M16 x 1.5	10	28.5	19
23.5213.0618	- 6	3/8"	M18 x 1.5	12	24.6	22
23.5213.0822	- 8	1/2"	M22 x 1.5	15	28.0	27
23.5213.1026	- 10	5/8"	M26 x 1.5	18	29.0	32

**MATERIAL:** Acero al carbono

**ACABADO:** Enchapado sin cromo-(VI) / conforme a ROHS

**VERSIONES:** Acero inoxidable (agregue una 'S' al final de la REFERENCIA)

# Hembra Métrica Giratoria Asiento Cono 24°/60°, Codo 90° (DKL)

23.5293.  
DIN 3868

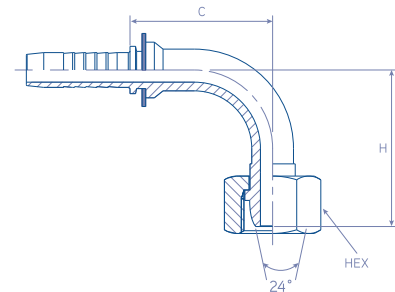

REFERENCIA	manguera tabla medidas	manguera Ø pulg.	hilo pulg.	d tubo mm	Corte C mm	H mm	HEX mm
23.5293.0414	- 4	1/4"	M14 x 1.5	8	28.0	30.5	17
23.5293.0516	- 5	5/16"	M16 x 1.5	10	30.5	33.0	19
23.5293.0518	- 5	5/16"	M18 x 1.5	12	36.0	36.0	22
23.5293.0616	- 6	3/8"	M16 x 1.5	10	34.0	36.0	19
23.5293.0618	- 6	3/8"	M18 x 1.5	12	36.0	36.0	22
23.5293.0822	- 8	1/2"	M22 x 1.5	15	38.2	40.5	27
23.5293.1026	- 10	5/8"	M26 x 1.5	18	54.0	52.0	32

**MATERIAL:** Acero al carbono

**ACABADO:** Enchapado sin cromo-(VI) / conforme a ROHS

**VERSIONES:** Acero inoxidable (agregue una 'S' al final de la REFERENCIA)



# Macho Métrico Serie Francesa Asiento Cono 24° (AGF)

23.1200.

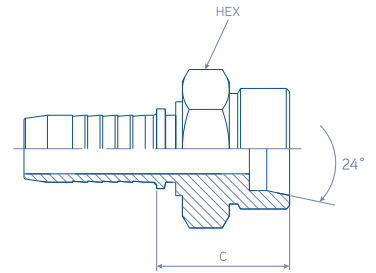

REFERENCIA	manguera tabla medidas	manguera Ø pulg.	hilo pulg.	d-tubo mm	C corte mm	HEX mm
23.1200.0520	- 5	5/16"	M20 x 1.5	13.25	27.5	22
23.1200.0620	- 6	3/8"	M20 x 1.5	13.25	27.5	22
23.1200.0824	- 8	1/2"	M24 x 1.5	16.75	32.0	24
23.1200.1030	- 10	5/8"	M30 x 1.5	21.25	32.5	30
23.1200.1230	- 12	3/4"	M30 x 1.5	21.25	36.0	30
23.1200.1236	- 12	3/4"	M36 x 1.5	26.75	36.2	36
23.1200.1645	- 16	1"	M45 x 1.5	33.50	41.2	46

**MATERIAL:** Acero al carbono

**ACABADO:** Enchapado sin cromo-(VI) / conforme a ROHS

**VERSIONES:** Acero inoxidable (agregue una 'S' al final de la REFERENCIA)

# Hembra Métrica Serie Francesa Asiento Cono 24° (DKF)

23.5513.

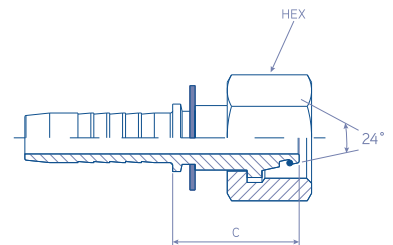

REFERENCIA	manguera tabla medidas	manguera Ø pulg.	hilo pulg.	d-tubo mm	C corte mm	HEX mm
23.5513.0520	- 5	5/16"	M20 x 1.5	13.25	27.5	27
23.5513.0620	- 6	3/8"	M20 x 1.5	13.25	27.5	27
23.5513.0824	- 8	1/2"	M24 x 1.5	16.75	32.0	30
23.5513.1030	- 10	5/8"	M30 x 1.5	21.25	32.5	36
23.5513.1230	- 12	3/4"	M30 x 1.5	21.25	36.0	36
23.5513.1236	- 12	3/4"	M36 x 1.5	26.75	36.2	46
23.5513.1645	- 16	1"	M45 x 1.5	33.50	41.2	55

**MATERIAL:** Acero al carbono

**ACABADO:** Enchapado sin cromo-(VI) / conforme a ROHS

**VERSIONES:** Acero inoxidable (agregue una 'S' al final de la REFERENCIA)

# Hembra Métrica Giratoria Serie Francesa Asiento Cono 24°, Codo 90° (DKF)

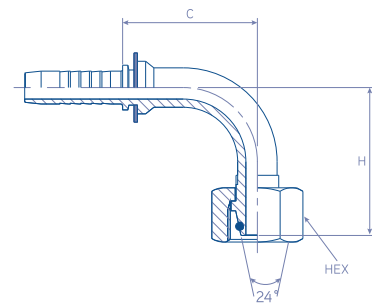

23.5593.

REFERENCIA	manguera tabla medidas	manguera Ø pulg.	hilo pulg.	d tube mm	Corte C mm	H mm	HEX mm
23.5593.0520	- 5	5/16"	M20 x 1.5	13.25	30.5	36.0	27
23.5593.0620	- 6	3/8"	M20 x 1.5	13.25	30.5	36.0	27
23.5593.0824	- 8	1/2"	M24 x 1.5	16.75	41.0	42.5	30
23.5593.1030	- 10	5/8"	M30 x 1.5	21.25	55.5	57.5	36
23.5593.1236	- 12	3/4"	M36 x 1.5	26.75	55.5	60.0	46
23.5593.1645	- 16	1"	M45 x 1.5	33.50	74.0	75.0	55

**MATERIAL:** Acero al carbono

**ACABADO:** Enchapado sin cromo-(VI) / conforme a ROHS

**VERSIONES:** Acero inoxidable (agregue una 'S' al final de la REFERENCIA)

# Hembra Giratoria Jis Asiento Cono 60° (MITSUBISHI)

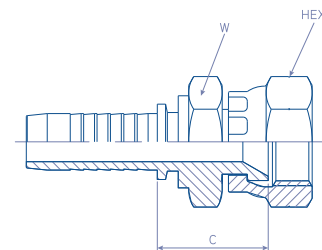

23.3712.

JIS B8363

REFERENCIA	manguera tabla medidas	manguera Ø pulg.	hilo pulg.	d-tubo mm	C corte mm	W mm	HEX mm
23.3712.0404	-4	1/4"	1/4" - 19	21	19	19	19
23.3712.0606	-6	3/8"	3/8" - 19	22	22	19	19
23.3712.0808	-8	1/2"	1/2" - 14	25	27	22	22
23.3712.1212	-12	3/4"	3/4" - 14	28	32	30	30
23.3712.1616	-16	1"	1" - 11	33	38	32	32
23.3712.2020	-20	1.1/4"	1.1/4" - 11	35	50	46	46
23.3712.2424	-24	1.1/2"	1.1/2" - 11	28	55	50	50

**MATERIAL:** Acero al carbono

**ACABADO:** Enchapado sin cromo-(VI) / conforme a ROHS

**VERSIONES:** Acero inoxidable (agregue una 'S' al final de la REFERENCIA)



# Hembra Giratoria KOMATSU Asiento Cono 60°

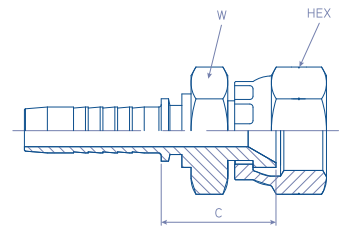

23.5911.  
JIS B8363

REFERENCIA	manguera tabla medidas	manguera Ø pulg.	hilo pulg.	d tubo mm	Corte C mm	W mm	HEX mm
23.5911.0414	-4	1/4"	M14 x 1.5	22.2	19	27	19
23.5911.0616	-5	5/16"	M16 x 1.5	23.5	22	27	19
23.5911.0618	-6	3/8"	M18 x 1.5	24.5	24	30	19
23.5911.0822	-8	1/2"	M22 x 1.5	27.0	27	36	22
23.5911.1024	-10	5/8"	M24 x 1.5	28.5	32	46	24
23.5911.1230	-12	3/4"	M30 x 1.5	31.7	36	55	30
23.5911.1633	-16	1"	M33 x 1.5	33.5	41	36	32
23.5911.2036	-20	1,1/4"	M36 x 1.5	37.5	46	46	41
23.5911.2442	-24	1,1/2"	M42 x 1.5	42.0	55	55	50

**MATERIAL:** Acero al carbono

**ACABADO:** Enchapado sin cromo-(VI) / conforme a ROHS

**VERSIONES:** Acero inoxidable (agregue una 'S' al final de la REFERENCIA)

# Espiga con Tubo Métrico (BEL)

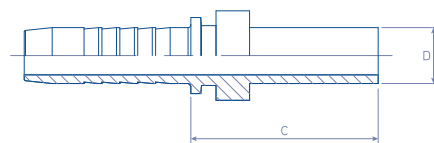

23.6000.

REFERENCIA	manguera	manguera Ø	d-tubo	C corte
	tabla medidas	pulg.	pulg.	mm
23.6000.0304	-3	3/16"	4	24.5
23.6000.0306	-3	3/16"	6	29.5
23.6000.0308	-3	3/16"	8	31.0
23.6000.0406	-4	1/4"	6	28.0
23.6000.0408	-4	1/4"	8	30.5
23.6000.0410	-4	1/4"	10	33.0
23.6000.0412	-4	1/4"	12	33.0
23.6000.0510	-5	5/16"	10	33.5
23.6000.0512	-5	5/16"	12	33.5
23.6000.0610	-6	3/8"	10	30.5
23.6000.0612	-6	3/8"	12	30.5
23.6000.0614	-6	3/8"	14	30.5
23.6000.0615	-6	3/8"	15	30.5
23.6000.0814	-8	1/2"	14	36.0
23.6000.0815	-8	1/2"	15	32.0
23.6000.0816	-8	1/2"	16	37.0
23.6000.0818	-8	1/2"	18	37.0
23.6000.1018	-10	5/8"	18	34.0
23.6000.1020	-10	5/8"	20	44.0
23.6000.1022	-10	5/8"	22	44.5
23.6000.1220	-12	3/4"	20	44.5
23.6000.1222	-12	3/4"	22	36.5
23.6000.1225	-12	3/4"	25	49.5
23.6000.1625	-16	1"	25	51.0
23.6000.1628	-16	1"	28	40.0
23.6000.1630	-16	1"	30	54.0
23.6000.1638	-16	1"	38	60.0
23.6000.2030	-20	1.1/4"	30	58.0
23.6000.2035	-20	1.1/4"	35	48.0
23.6000.2038	-20	1.1/4"	38	62.0
23.6000.2438	-24	1.1/2"	38	63.0
23.6000.2442	-24	1.1/2"	42	50.0

**MATERIAL:** Acero al carbono

**ACABADO:** Enchapado sin cromo-(VI) / conforme a ROHS

**VERSIONES:** Acero inoxidable (agregue una 'S' al final de la REFERENCIA)



# Espiga con Tubo Métrico, Codo 45° (BEL 45)

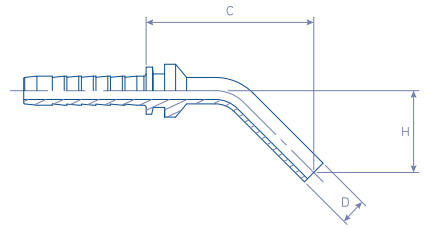

23.6040.

REFERENCIA	manguera	manguera Ø	d tubo	Corte C	H
	tabla medidas	pulg.	pulg.	mm	mm
23.6040.0306	-3	3/16"	6	33	26
23.6040.0308	-3	3/16"	8	38	26
23.6040.0406	-4	1/4"	6	41	24
23.6040.0408	-4	1/4"	8	43	25
23.6040.0410	-4	1/4"	10	47	30
23.6040.0412	-4	1/4"	12	47	30
23.6040.0510	-5	5/16"	10	49	30
23.6040.0512	-5	5/16"	12	53	32
23.6040.0610	-6	3/8"	10	50	33
23.6040.0612	-6	3/8"	12	52	33
23.6040.0614	-6	3/8"	14	43	34
23.6040.0615	-6	3/8"	15	45	37
23.6040.0814	-8	1/2"	14	42	34
23.6040.0815	-8	1/2"	15	46	37
23.6040.0816	-8	1/2"	16	45	36
23.6040.0818	-8	1/2"	18	61	32
23.6040.1018	-10	5/8"	18	61	32
23.6040.1020	-10	5/8"	20	62	34
23.6040.1022	-10	5/8"	22	68	35
23.6040.1220	-12	3/4"	20	68	35
23.6040.1222	-12	3/4"	22	68	35
23.6040.1225	-12	3/4"	25	75	39
23.6040.1625	-16	1"	25	74	39
23.6040.1628	-16	1"	28	87	49
23.6040.1630	-16	1"	30	84	43
23.6040.2030	-20	1.1/4"	30	85	43
23.6040.2035	-20	1.1/4"	35	93	45
23.6040.2038	-20	1.1/4"	38	94	50
23.6040.2438	-24	1.1/2"	38	94	50
23.6040.2442	-24	1.1/2"	42	113	57

**MATERIAL:** Acero al carbono

**ACABADO:** Enchapado sin cromo-(VI) / conforme a ROHS

**VERSIONES:** Acero inoxidable (agregue una 'S' al final de la REFERENCIA)

# Espiga con Tubo Métrico, Codo 90° (BEL 90)

23.6090.

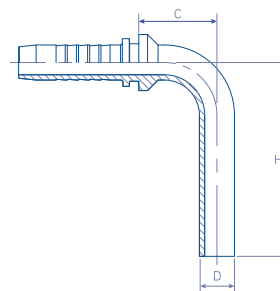

REFERENCIA	manguera	manguera Ø	d tubo	Corte C	H
	tabla medidas	pulg.	pulg.	mm	mm
23.6090.0306	-3	3/16"	6	24	37
23.6090.0308	-3	3/16"	8	24	39
23.6090.0406	-4	1/4"	6	23	32
23.6090.0408	-4	1/4"	8	25	34
23.6090.0410	-4	1/4"	10	25	43
23.6090.0412	-4	1/4"	12	25	37
23.6090.0510	-5	5/16"	10	29	40
23.6090.0512	-5	5/16"	12	29	45
23.6090.0610	-6	3/8"	10	27	40
23.6090.0612	-6	3/8"	12	30	44
23.6090.0614	-6	3/8"	14	33	45
23.6090.0615	-6	3/8"	15	38	53
23.6090.0814	-8	1/2"	14	33	49
23.6090.0815	-8	1/2"	15	39	53
23.6090.0816	-8	1/2"	16	42	56
23.6090.0818	-8	1/2"	18	42	57
23.6090.1018	-10	5/8"	18	42	57
23.6090.1020	-10	5/8"	20	42	66
23.6090.1022	-10	5/8"	22	53	71
23.6090.1220	-12	3/4"	20	49	66
23.6090.1222	-12	3/4"	22	54	71
23.6090.1225	-12	3/4"	25	57	76
23.6090.1625	-16	1"	25	58	76
23.6090.1628	-16	1"	28	65	83
23.6090.1630	-16	1"	30	66	89
23.6090.2030	-20	1.1/4"	30	67	89
23.6090.2035	-20	1.1/4"	35	77	97
23.6090.2038	-20	1.1/4"	38	81	106
23.6090.2438	-24	1.1/2"	38	81	106
23.6090.2442	-24	1.1/2"	42	92	118

**MATERIAL:** Acero al carbono

**ACABADO:** Enchapado sin cromo-(VI) / conforme a ROHS

**VERSIONES:** Acero inoxidable (agregue una 'S' al final de la REFERENCIA)



# Banjo Métrico (RNM)

23.6400.

DIN 7642

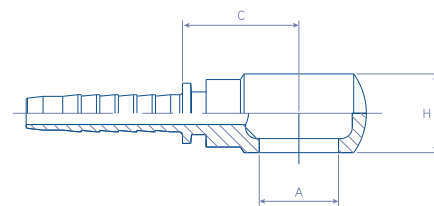

REFERENCIA	manguera	manguera Ø	Corte C	A	H
	tabla medidas	pulg.	pulg.	mm	mm
23.6400.0310	-3	3/16"	15.5	10.2	10.0
23.6400.0312	-3	3/16"	17.0	12.2	12.0
23.6400.0410	-4	1/4"	17.0	10.2	10.0
23.6400.0412	-4	1/4"	21.0	12.2	12.0
23.6400.0414	-4	1/4"	21.0	14.2	14.0
23.6400.0416	-4	1/4"	22.5	16.2	18.0
23.6400.0514	-5	5/16"	19.0	14.2	14.0
23.6400.0516	-5	5/16"	22.5	16.2	18.0
23.6400.0518	-5	5/16"	24.0	18.2	20.0
23.6400.0614	-6	3/8"	21.0	14.2	14.0
23.6400.0616	-6	3/8"	22.5	16.2	18.0
23.6400.0618	-6	3/8"	24.0	18.2	20.0
23.6400.0622	-6	3/8"	28.1	22.2	22.0
23.6400.0816	-8	1/2"	26.0	16.2	18.0
23.6400.0818	-8	1/2"	24.5	18.2	20.0
23.6400.0822	-8	1/2"	27.5	22.2	22.0
23.6400.1022	-10	5/8"	27.5	22.2	22.0
23.6400.1026	-10	5/8"	32.0	26.2	29.0
23.6400.1226	-12	3/4"	32.0	26.2	29.0
23.6400.1230	-12	3/4"	36.5	30.2	37.0
23.6400.1630	-16	1"	36.5	30.2	37.0

**MATERIAL:** Acero al carbono

**ACABADO:** Enchapado sin cromo-(VI) / conforme a ROHS

**VERSIONES:** Acero inoxidable (agregue una 'S' al final de la REFERENCIA)

# Banjo BSP (RNR)

23.6500.

BS 5200

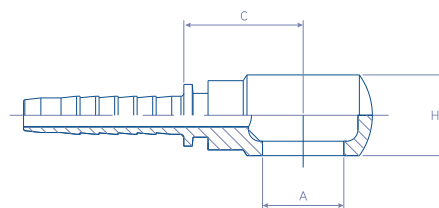

REFERENCIA	manguera tabla medidas	manguera Ø pulg.		Corte C mm	A mm	H mm
23.6500.0302	-3	3/16"	1/8"	19.0	1/8"	16.0
23.6500.0304	-3	3/16"	1/4"	20.0	1/4"	15.0
23.6500.0404	-4	1/4"	1/4"	19.2	1/4"	15.0
23.6500.0406	-4	1/4"	3/8"	21.7	3/8"	18.0
23.6500.0504	-5	5/16"	1/4"	19.0	1/4"	15.0
23.6500.0506	-5	5/16"	3/8"	22.5	3/8"	20.0
23.6500.0604	-6	3/8"	1/4"	19.5	1/4"	15.0
23.6500.0606	-6	3/8"	3/8"	22.0	3/8"	20.0
23.6500.0608	-6	3/8"	1/2"	27.5	1/2"	25.0
23.6500.0806	-8	1/2"	3/8"	22.5	3/8"	20.0
23.6500.0808	-8	1/2"	1/2"	28.0	1/2"	25.0
23.6500.1018	-10	5/8"	1/2"	28.0	1/2"	25.0
23.6500.1010	-10	5/8"	5/8"	27.5	5/8"	27.0
23.6500.1012	-10	5/8"	3/4"	31.5	3/4"	31.0
23.6500.1212	-12	3/4"	3/4"	32.0	3/4"	31.0
23.6500.1216	-12	3/4"	1"	39.7	1"	42.0
23.6500.1616	-16	1"	1"	40.5	1"	42.0

**MATERIAL:** Acero al carbono

**ACABADO:** Enchapado sin cromo-(VI) / conforme a ROHS

**VERSIONES:** Acero inoxidable (agregue una 'S' al final de la REFERENCIA)



# Perno Banjo BSP

88.1600.

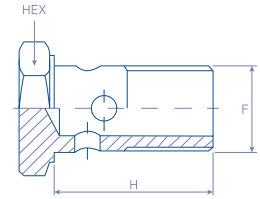

REFERENCIA	F pulg.	H mm	HEX mm
88.1600.02	1/8"	19.0	14
88.1600.04	1/4"	25.0	19
88.1600.06	3/8"	31.0	22
88.1600.08	1/2"	38.0	27
88.1600.10	5/8"	41.0	30
88.1600.12	3/4"	46.0	32
88.1600.16	1"	58.0	41

**MATERIAL:** Acero al carbono

**ACABADO:** Enchapado sin cromo-(VI) / conforme a ROHS

# Perno Banjo BSP Doble

88.1602.

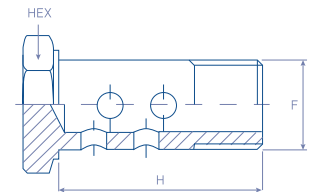

REFERENCIA	F pulg.	H mm	HEX mm
88.1602.02	1/8"	33.0	14
88.1602.04	1/4"	43.0	19
88.1602.06	3/8"	51.0	22
88.1602.08	1/2"	63.0	27
88.1602.12	3/4"	80.0	32
88.1602.16	1"	110.0	41
88.1600.16	1"	58.0	41

**MATERIAL:** Acero al carbono

**ACABADO:** Enchapado sin cromo-(VI) / conforme a ROHS

## Perno Banjo Métrico

88.1650.

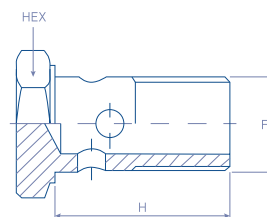

REFERENCIA	F mm	H mm	HEX mm
88.1650.08	M8 x 1.0	16.0	12
88.1650.10	M10 x 1.0	19.0	14
88.1650.12	M12 x 1.5	23.0	17
88.1650.14	M14 x 1.5	25.0	19
88.1650.16	M16 x 1.5	31.0	22
88.1650.18	M18 x 1.5	36.0	24
88.1650.20	M20 x 1.5	38.0	27
88.1650.22	M22 x 1.5	38.0	27
88.1650.24	M24 x 1.5	41.0	30
88.1650.26	M26 x 1.5	46.0	32
88.1650.30	M30 x 1.5	58.0	38

**MATERIAL:** Acero al carbono

**ACABADO:** Enchapado sin cromo-(VI) / conforme a ROHS

## Perno Banjo Métrico Doble

88.1652.

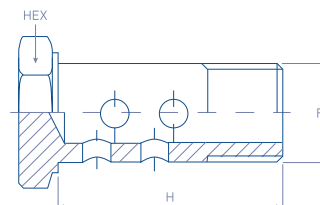

REFERENCIA	F mm	H mm	Hex mm
88.1652.08	M8 x 1.0	29.0	12
88.1652.10	M10 x 1.0	33.0	14
88.1652.12	M12 x 1.5	37.0	17
88.1652.14	M14 x 1.5	43.0	19
88.1652.16	M16 x 1.5	51.0	22
88.1652.18	M18 x 1.5	57.0	24
88.1652.22	M22 x 1.5	63.0	27

**MATERIAL:** Acero al carbono

**ACABADO:** Enchapado sin cromo-(VI) / conforme a ROHS



# Unión de Manguera

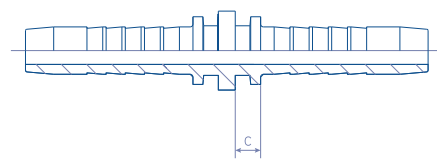

23.8100.

REFERENCIA	manguera	manguera	Corte C
	tabla medidas	pulg.	mm
23.8100.03	-3	3/16"	17.0
23.8100.04	-4	1/4"	17.0
23.8100.05	-5	5/16"	17.0
23.8100.06	-6	3/8"	17.0
23.8100.08	-8	1/2"	18.0
23.8100.10	-10	5/8"	18.0
23.8100.12	-12	3/4"	19.0
23.8100.16	-16	1"	21.0

# Espiga Soldable

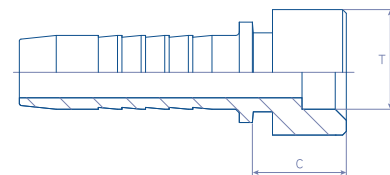

23.8150.

REFERENCIA	manguera	manguera	Corte C	T
	tabla medidas	pulg.	mm	pulg.
23.8150.03	-3	3/16"	11.0	6.0
23.8150.04	-4	1/4"	12.5	8.0
23.8150.05	-5	5/16"	13.0	10.0
23.8150.06	-6	3/8"	14.0	12.0
23.8150.08	-8	1/2"	15.5	15.0
23.8150.10	-10	5/8"	16.5	18.0
23.8150.12	-12	3/4"	18.0	20.0
23.8150.16	-16	1"	20.5	25.0

**MATERIAL:** Acero al carbono

**ACABADO:** Enchapado sin cromo-(VI) / conforme a ROHS

**VERSIONES:** Acero inoxidable (agregue una 'S' al final de la REFERENCIA)

## Macho de Bloqueo

23.8300.

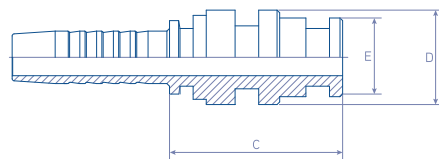

REFERENCIA	manguera tabla medidas	manguera Ø pulg.	Corte C pulg.	D mm	E mm
23.8300.04	-4	1/4"	35.5	14.9	9.9
23.8300.06	-6	3/8"	34.5	19.9	13.9
23.8300.08	-8	1/2"	35.0	23.9	17.9
23.8300.10	-10	5/8"	36.0	25.9	20.9
23.8300.12	-12	3/4"	35.5	28.9	23.9
23.8300.16	-16	1"	44.0	38.9	30.9
23.8300.20	-20	1.1/4"	47.0	45.9	37.9
23.8300.24	-24	1.1/2"	51.0	54.9	46.9
23.8300.32	-32	2"	57.0	63.9	55.9

**MATERIAL:** Acero al carbono

**ACABADO:** Enchapado sin cromo-(VI) / conforme a ROHS

## Hembra Hidrolavadora Giratoria (Karcher)

23.6213.

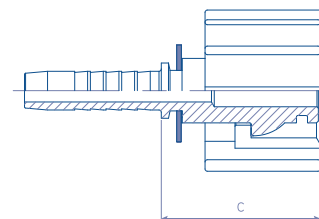

REFERENCIA	manguera tabla medidas	manguera pulg.	hilo	Corte C mm
23.6213.0422	-4	1/4"	M22 x 1.5	31.0
23.6213.0522	-4	5/16"	M22 x 1.5	31.0
23.6213.0622	-5	3/8"	M22 x 1.5	31.0

**MATERIAL:** Acero al carbono

**ACABADO:** Enchapado sin cromo-(VI) / conforme a ROHS



## Espiga Hidrolavadora con O' ring (Karcher)

23.6214.

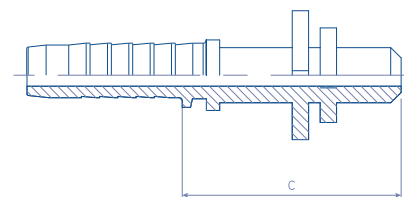

REFERENCIA	manguera	manguera	tubo	Corte C
	tabla medidas	pulg.		mm
23.6214.04	-4	1/4"	10.0	33.0
23.6214.05	-4	5/16"	10.0	33.0

**MATERIAL:** Acero al carbono

**ACABADO:** Enchapado sin cromo-(VI) / conforme a ROHS

## Mango de Caucho Hidrolavadora

11.800.



REFERENCIA	manguera	manguera	I.D.
	tabla medidas	pulg.	
11.800.18	-5	5/16"	18.0
11.800.21	-6	3/8"	21.0

**MATERIAL:** Rubber

**VERSIONES:** Blue colour (add an 'A' at the end of the REFERENCIA)

## Sellos Adheridos BSP (Golilla Bonded)

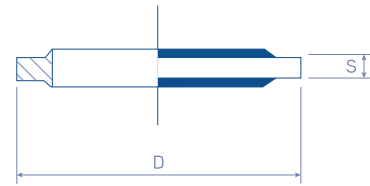

88.2003.

REFERENCIA	I pulg.	S mm	D mm
88.2003.02	1/8"	2.1	16.0
88.2003.04	1/4"	2.1	20.5
88.2003.02	1/8"	2.1	16.0
88.2003.04	1/4"	2.1	20.5
88.2003.02	1/8"	2.1	16.0
88.2003.04	1/4"	2.1	20.5
88.2003.02	1/8"	2.1	16.0
88.2003.04	1/4"	2.1	20.5
88.2003.02	1/8"	2.1	16.0
88.2003.04	1/4"	2.1	20.5
88.2003.02	1/8"	2.1	16.0
88.2003.04	1/4"	2.1	20.5

**MATERIAL:** Anillo de caucho (NBR) y anillo de acero templado

**ACABADO:** Enchapado sin cromo-(VI) / conforme a ROHS

**VERSIONES:** Acero inoxidable (agregue una 'S' al final de la REFERENCIA)

## Sellos Adheridos Métricos (Golilla Bonded)

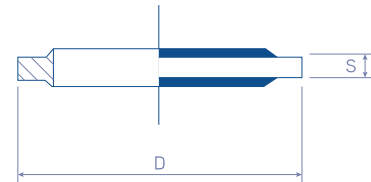

88.2004.

REFERENCIA	I pulg.	S mm	D mm
88.2004.06	6	1.3	12.0
88.2004.08	8	1.3	14.0
88.2004.10	10	2.1	16.0
88.2004.12	12	2.1	18.0
88.2004.14	14	2.1	22.0
88.2004.16	16	2.1	25.0
88.2004.18	18	2.5	25.0
88.2004.20	20	2.5	28.0
88.2004.22	22	2.5	32.0
88.2004.24	24	2.5	33.0
88.2004.26	26	2.5	35.0
88.2004.30	30	2.5	39.0

**MATERIAL:** Anillo de caucho (NBR) y anillo de acero templado

**ACABADO:** Enchapado sin cromo-(VI) / conforme a ROHS

**VERSIONES:** Acero inoxidable (agregue una 'S' al final de la REFERENCIA)



# Brida Dividida 3000 PSI (código 61)

88.5300.

ISO 6162-1 / SAE J518

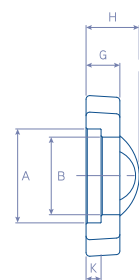
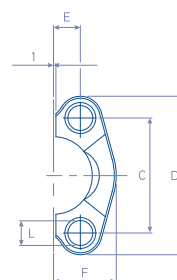

REFERENCIA	Tamaño	A	B	C	D	E	F	G	H	K	L	Pernos	
	pulg.	mm	mm	mm	mm	mm	mm	mm	mm	mm	mm	M	UNC
88.5300.08	1/2"	31	24	38	54	9	23	13	19	6	9	M8	5/16"
88.5300.12	3/4"	39	32	48	65	11	26	14	22	6	11	M10	3/8"
88.5300.16	1"	45	38	52	70	13	29	16	24	7	11	M10	3/8"
88.5300.20	1.1/4"	52	44	59	79	15	36	14	22	7	12	M10	7/16"
88.5300.24	1.1/2"	61	51	70	94	18	41	16	25	7	15	M14	1/2"
88.5300.32	2"	72	63	78	102	21	48	16	26	9	14	M12	1/2"

**MATERIAL:** Acero al carbono

**ACABADO:** Enchapado sin cromo-(VI) / conforme a ROHS

**VERSIONES:** Brida sin corte (88.5302)

# Brida Dividida 6000 PSI (código 62)

88.5600.

ISO 6162-1 / SAE J518

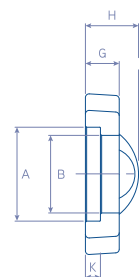
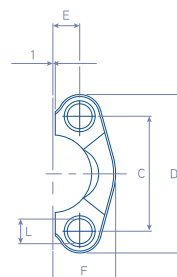

REFERENCIA	Tamaño	A	B	C	D	E	F	G	H	K	L	Pernos	
	pulg.	mm	mm	mm	mm	mm	mm	mm	mm	mm	mm	M	UNC
88.5600.08	1/2"	33	25	41	56	9	24	16	22	7	9	M8	5/16"
88.5600.12	3/4"	42	33	51	71	12	30	19	28	8	11	M10	3/8"
88.5600.16	1"	48	39	57	81	14	35	24	33	9	13	M12	7/16"
88.5600.20	1.1/4"	55	44	67	95	16	39	27	38	10	15	M14	1/2"
88.5600.24	1.1/2"	64	52	79	113	18	48	30	43	12	17	M16	5/8"
88.5600.32	2"	80	68	97	133	22	57	37	52	12	21	M20	3/4"

**MATERIAL:** Acero al carbono

**ACABADO:** Enchapado sin cromo-(VI) / conforme a ROHS

**VERSIONES:** Brida sin corte (88.5602)

# Conexiones Hidráulicas Interlock

---

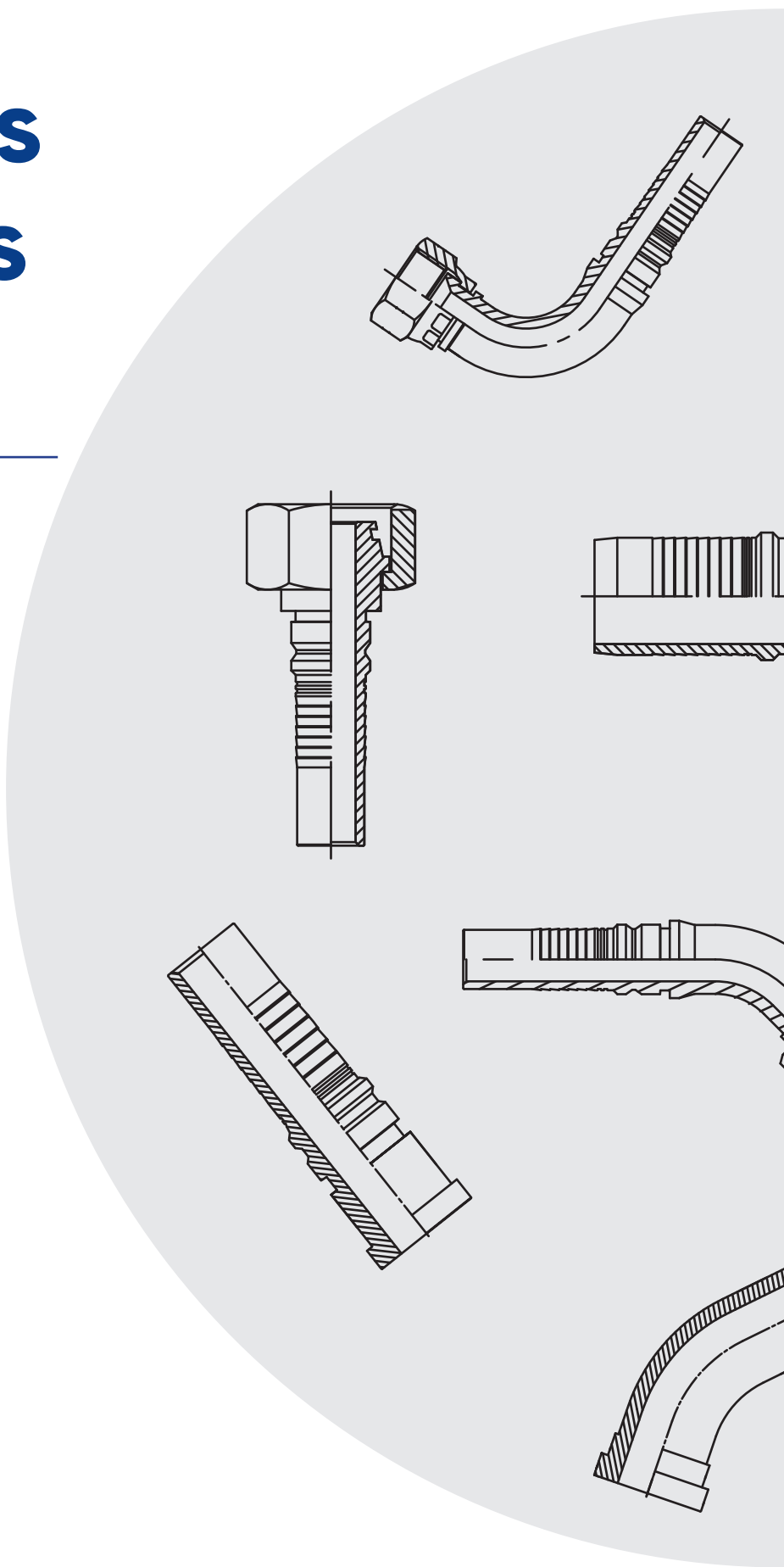

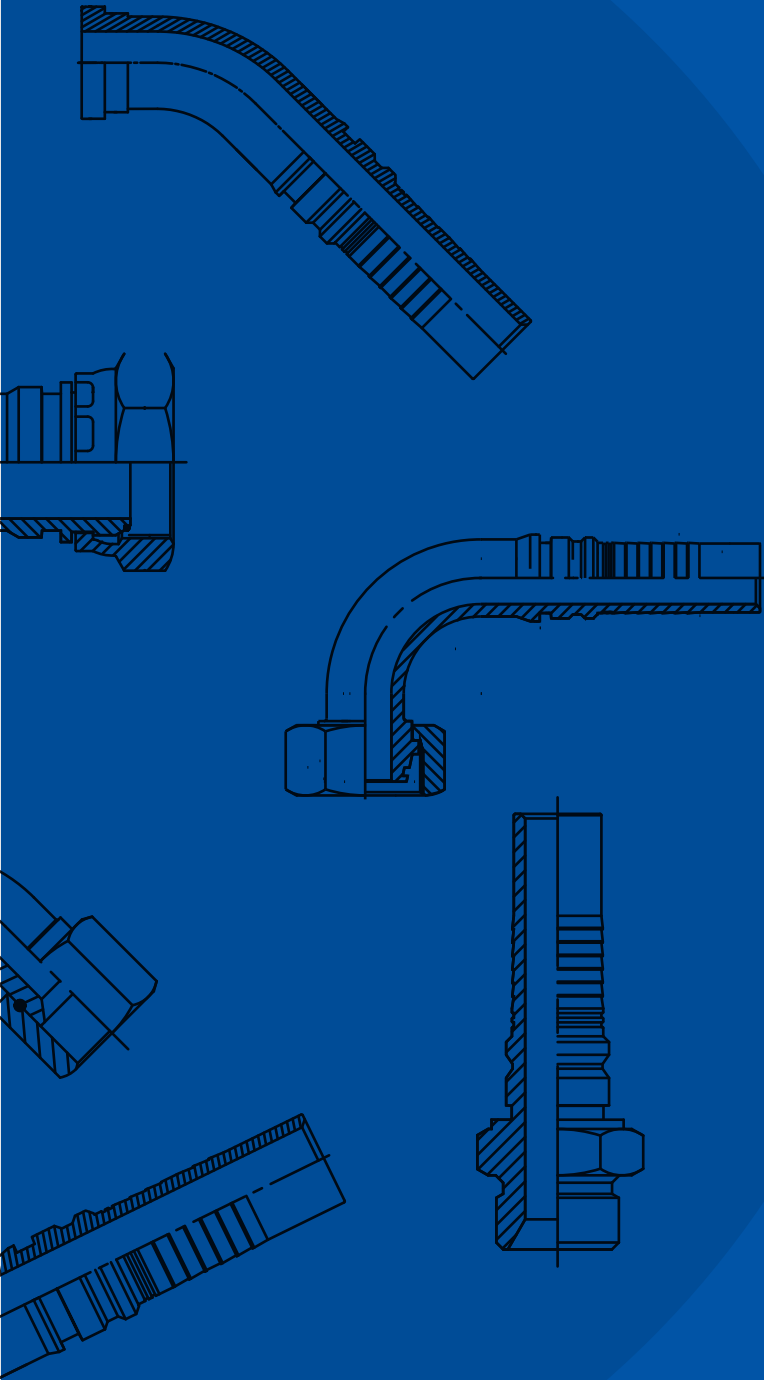

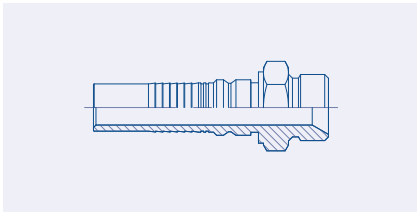

**Hilo Paralelo BSP Macho de Interbloqueo (AGR)**

26.0100

pág. 94

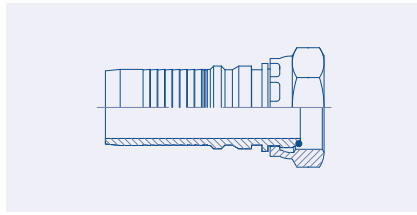

**Hilo Paralelo BSP Hembra Giratoria Interlock con O' Ring (DKOR)**

26.3112

pág. 94

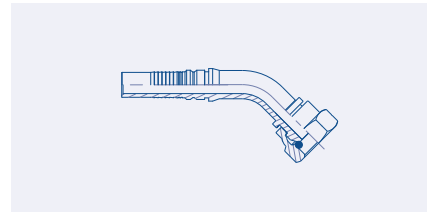

**Hilo Paralelo BSP Hembra Giratoria Interlock con O' Ring, Codo 45° (DKOR 45°)**

26.3142

pág. 95

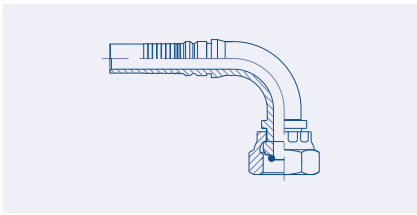

**Hilo Paralelo BSP Hembra Giratoria Interlock con O' Ring, Codo 90° (DKOR 90°)**

26.3192

pág. 95

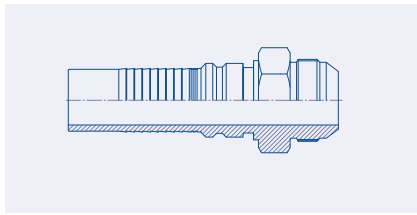

**Macho JIC 37° Interlock (AGJ)**

26.2000

pág. 96

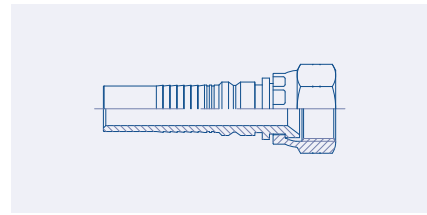

**Hembra Giratoria JIC 37° Interlock (DKJ)**

26.4012

pág. 96

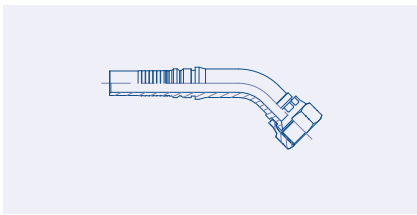

**Hembra Giratoria JIC 37° Interlock, Codo 45° (DKJ 45°)**

26.4042

pág. 97

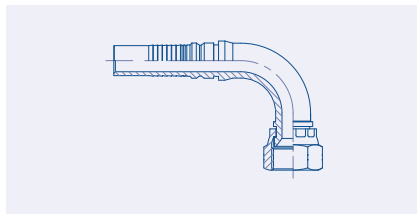

**Hembra Giratoria JIC 37° Interlock, Codo 90° (DKJ 90°)**

26.4092

pág. 97

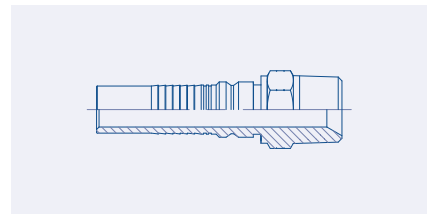

**Hilo NPTF Macho Interlock (AGN)**

26.0400

pág. 98

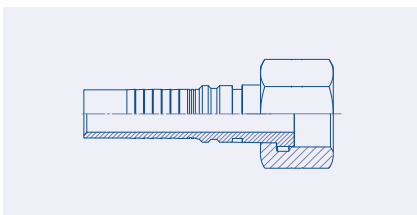

**Hembra Giratoria Interlock ORFS**

26.4414

pág. 98

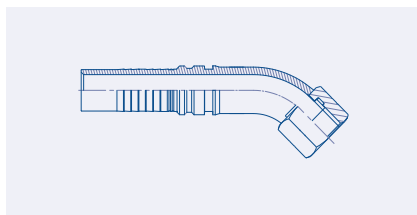

**Hembra Giratoria Interlock ORFS, Codo 45°**

26.4444

pág. 99

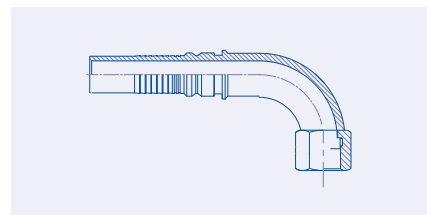

**Hembra Giratoria Interlock ORFS, Codo 90°**

26.4494

pág. 99

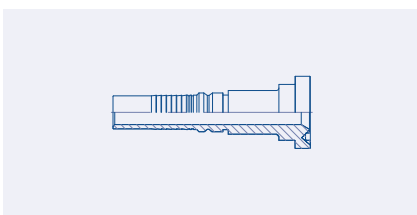

**Flange SAE Recta Interlock (código 61) 3000 PSI (SFL)**

26.7013

pág. 100

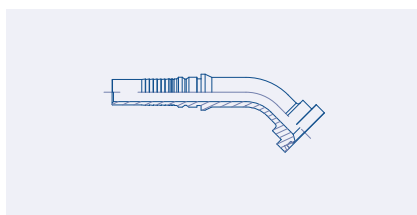

**Flange SAE Recta Interlock (código 61) 3000 PSI, Codo 45° (SFL 45°)**

26.7043

pág. 100

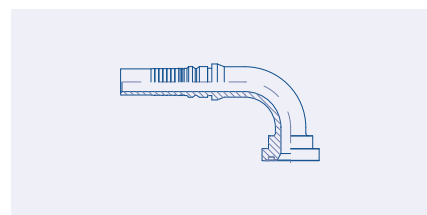

**Flange SAE Recta Interlock (código 61) 3000 PSI, Codo 90° (SFL 90°)**

26.7093

pág. 101

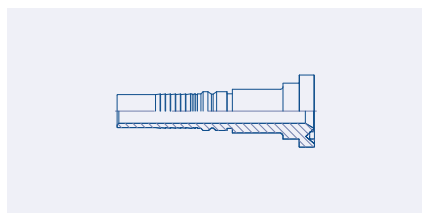

**Flange SAE Recta Interlock  
(código 62) 6000 PSI (SFS)**

26.7016

pág. 101

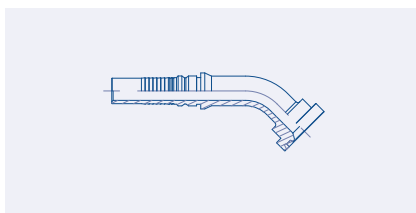

**Flange SAE Interlock (código 62)  
6000 PSI, Codo 45° (SFS 45°)**

26.7046

pág. 102

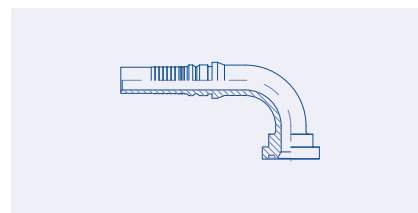

**Flange SAE Interlock (código 62)  
6000 PSI, Codo 90° (SFS 90°)**

26.7096

pág. 102

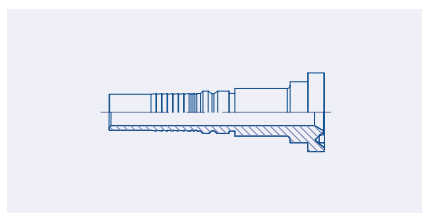

**Flange Recta Interlock  
SUPERCAT**

26.7116

pág. 103

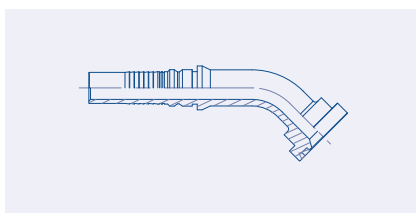

**Flange Interlock SUPERCAT,  
Codo 45°**

26.7146

pág. 103

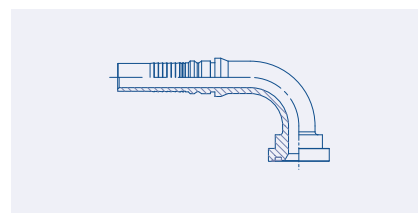

**Flange Interlock SUPERCAT,  
Codo 90°**

26.7196

pág. 104

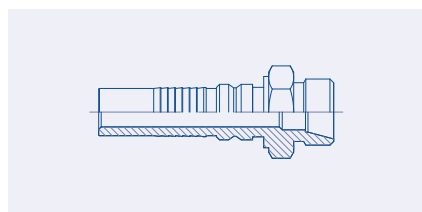

**Macho Métrico Interlock, Serie  
Pesada Asiento Cono 24° (CES)**

26.1100

pág. 104

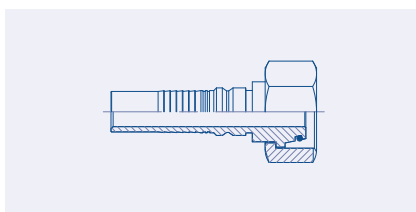

**Hembra Métrica Giratoria  
Interlock, Serie Pesada Asiento  
Cono 24° (DKOS)**

26.5113

pág. 105

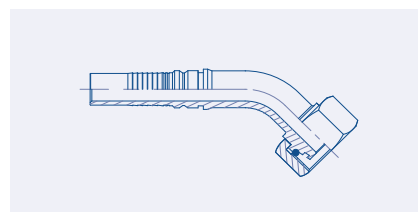

**Hembra Métrica Giratoria  
Interlock, Serie Pesada Asiento  
Cono 24° , Codo 45° (DKOS 45)**

26.5143

pág. 105

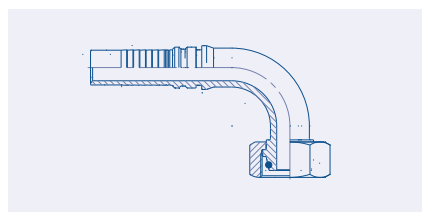

**Hembra Métrica Giratoria  
Interlock, Serie Pesada Asiento  
Cono 24° , Codo 90° (DKOS 90)**

26.5193

pág. 106

## Hilo Paralelo BSP Macho Interlock (AGR)

26.0100.

ISO 12151-6 / ISO 8434-6 / BS 5200

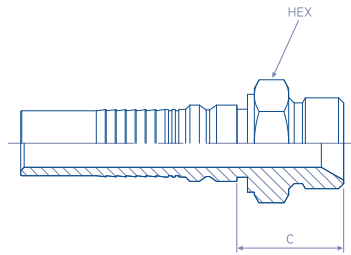

REFERENCIA	manguera tabla medidas	manguera Ø pulg.	hilo pulg.	C Corte mm	HEX mm
26.0100.1212	-12	3/4"	3/4" - 14	36.5	32
26.0100.1616	-16	1"	1" - 11	42.5	41
26.0100.2020	-20	1.1/4"	1.1/4" - 11	46.7	50
26.0100.2424	-24	1.1/2"	1.1/2" - 11	49.5	55
26.0100.3232	-32	2"	2" - 11	56.5	70

**MATERIAL:** Acero al carbono

**ACABADO:** Enchapado sin cromo-(VI) / conforme a ROHS

**VERSIONES:** Acero inoxidable (agregue una 'S' al final de la REFERENCIA)

## Hilo Paralelo BSP Hembra Giratoria Interlock con O' Ring (DKOR)

26.3112.

ISO 12151-6 / ISO 8434-6 / BS 5200

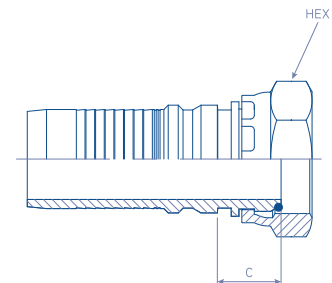

REFERENCIA	manguera tabla medidas	manguera Ø pulg.	hilo pulg.	C Corte mm	HEX mm
26.3112.1212	-12	3/4"	3/4" - 14	22.0	32
26.3112.1616	-16	1"	1" - 11	25.2	38
26.3112.2020	-20	1.1/4"	1.1/4" - 11	29.2	50
26.3112.2424	-24	1.1/2"	1.1/2" - 11	30.5	55
26.3112.3232	-32	2"	2" - 11	31.0	70

**MATERIAL:** Acero al carbono

**ACABADO:** Enchapado sin cromo-(VI) / conforme a ROHS

**VERSIONES:** Acero inoxidable (agregue una 'S' al final de la REFERENCIA)

**NOTAS:** En tamaños más grandes, las tuercas pueden suministrarse con tuerca con seguro



# Hilo Paralelo BSP Hembra Giratoria Interlock con O' Ring, Codo 45° (DKOR 45°)

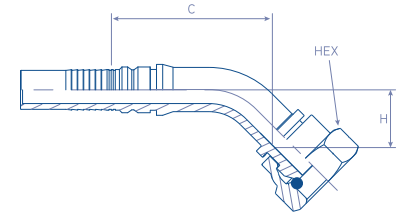

26.3142.

ISO 12151-6 / ISO 8434-6 / BS 5200

REFERENCIA	manguera tabla medidas	manguera Ø pulg.	hilo pulg.	C Corte mm	H mm	HEX mm
26.3142.1212	-12	3/4"	3/4" - 14	67.6	28.3	32
26.3142.1616	-16	1"	1" - 11	80.7	33.8	38
26.3142.2020	-20	1.1/4"	1.1/4" - 11	94.5	37.5	50
26.3142.2424	-24	1.1/2"	1.1/2" - 11	116.5	49.2	55
26.3142.3232	-32	2"	2" - 11	136.5	59.6	70

**MATERIAL:** Acero al carbono  
**ACABADO:** Enchapado sin  
cromo-(VI) / conforme a ROHS

**VERSIONES:** Acero inoxidable  
(agregue una 'S' al final de la  
REFERENCIA)

**NOTAS:** En tamaños más grandes,  
las tuercas pueden suministrarse con  
tuerca con seguro

# Hilo Paralelo BSP Hembra Giratoria Interlock con O' Ring, Codo 90° (DKOR 90°)

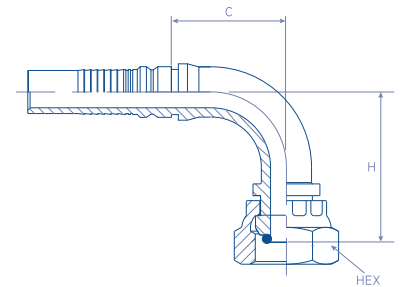

26.3192.

ISO 12151-6 / ISO 8434-6 / BS 5200

REFERENCIA	manguera tabla medidas	manguera Ø pulg.	hilo pulg.	C Corte mm	H mm	HEX mm
26.3192.1212	-12	3/4"	3/4" - 14	57.0	55.0	32
26.3192.1616	-16	1"	1" - 11	73.0	71.0	38
26.3192.2020	-20	1.1/4"	1.1/4" - 11	87.0	77.0	50
26.3192.2424	-24	1.1/2"	1.1/2" - 11	105.0	100.0	55
26.3192.3232	-32	2"	2" - 11	135.0	128.0	70

**MATERIAL:** Acero al carbono  
**ACABADO:** Enchapado sin  
cromo-(VI) / conforme a ROHS

**VERSIONES:** Acero inoxidable  
(agregue una 'S' al final de la  
REFERENCIA)

**NOTAS:** En tamaños más grandes,  
las tuercas pueden suministrarse con  
tuerca con seguro

# Macho JIC 37° Interlock (AGJ)

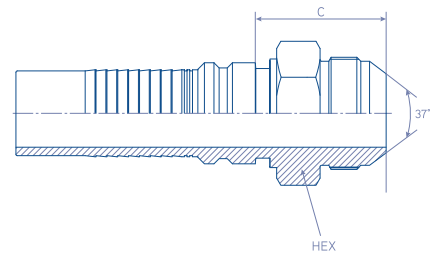

26.2000.

ISO 12151-5 / ISO 8434-2 / SAE J516 / SAE J514

REFERENCIA	manguera tabla medidas	manguera Ø pulg.	hilo pulg.	C Corte mm	HEX mm
26.2000.1212	-12	3/4"	1.1/16" - 12	38.0	27
26.2000.1616	-16	1"	1.5/16" - 12	43.1	36
26.2000.2020	-20	1.1/4"	1.5/8" - 12	48.0	46
26.2000.2424	-24	1.1/2"	1.7/8" - 12	52.5	50
26.2000.3232	-32	2"	2.1/2" - 12	64.0	65

**MATERIAL:** Acero al carbono

**ACABADO:** Enchapado sin cromo-(VI) / conforme a ROHS

**VERSIONES:** Acero inoxidable (agregue una 'S' al final de la REFERENCIA)

# Hembra Giratoria JIC 37° Interlock (DKJ)

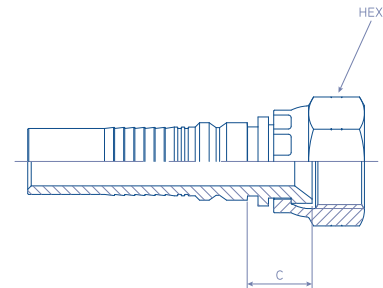

26.4012.

ISO 12151-5 / ISO 8434-2 / SAE J516 / SAE J514

REFERENCIA	manguera tabla medidas	manguera Ø pulg.	hilo pulg.	C Corte mm	HEX mm
26.4012.1212	-12	3/4"	1.1/16" - 12	20.0	32
26.4012.1616	-16	1"	1.5/16" - 12	22.3	41
26.4012.2020	-20	1.1/4"	1.5/8" - 12	22.2	50
26.4012.2424	-24	1.1/2"	1.7/8" - 12	23.5	57
26.4012.3232	-32	2"	2.1/2" - 12	30.5	75

**MATERIAL:** Acero al carbono  
**ACABADO:** Enchapado sin cromo-(VI) / conforme a ROHS

**VERSIONES:** Acero inoxidable (agregue una 'S' al final de la REFERENCIA)

**NOTAS:** En tamaños más grandes, las tuercas pueden suministrarse con tuerca con seguro



# Hembra Giratoria JIC 37° Interlock, Codo 45° (DKJ 45°)

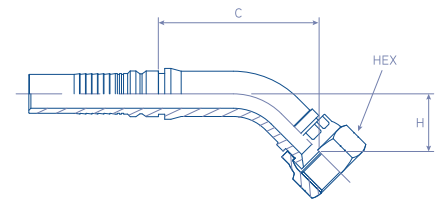

26.4042.

ISO 12151-5 / ISO 8434-2 / SAE J516 / SAE J514

REFERENCIA	manguera tabla medidas	manguera Ø pulg.	hilo pulg.	C Corte mm	H mm	HEX mm
26.4042.1212	-12	3/4"	1.1/16" - 12	68.0	28.3	32
26.4042.1616	-16	1"	1.5/16" - 12	81.0	32.0	38
26.4042.2020	-20	1.1/4"	1.5/8" - 12	94.5	37.5	50
26.4042.2424	-24	1.1/2"	1.7/8" - 12	116.5	49.2	55
26.4042.3232	-32	2"	2.1/2" - 12	148.0	64.0	75

**MATERIAL:** Acero al carbono  
**ACABADO:** Enchapado sin  
cromo-(VI) / conforme a ROHS

**VERSIONES:** Acero inoxidable  
(agregue una 'S' al final de la  
REFERENCIA)

**NOTAS:** En tamaños más grandes,  
las tuercas pueden suministrarse con  
tuerca con seguro

# Hembra Giratoria JIC 37° Interlock, Codo 90° (DKJ 90°)

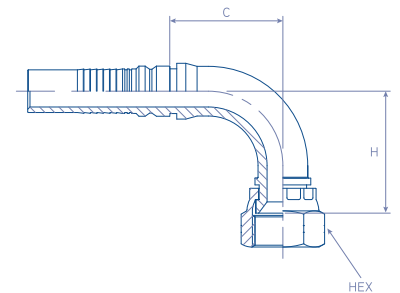

26.4092.

ISO 12151-5 / ISO 8434-2 / SAE J516 / SAE J514

REFERENCIA	manguera tabla medidas	manguera Ø pulg.	hilo pulg.	C Corte mm	H mm	HEX mm
26.4092.1212	-12	3/4"	1.1/16" - 12	59.0	55.0	32
26.4092.1616	-16	1"	1.5/16" - 12	75.0	71.0	38
26.4092.2020	-20	1.1/4"	1.5/8" - 12	89.0	77.0	50
26.4092.2424	-24	1.1/2"	1.7/8" - 12	107.0	100.0	57
26.4092.3232	-32	2"	2.1/2" - 12	135.0	140.0	75

**MATERIAL:** Acero al carbono  
**ACABADO:** Enchapado sin  
cromo-(VI) / conforme a ROHS

**VERSIONES:** Acero inoxidable  
(agregue una 'S' al final de la  
REFERENCIA)

**NOTAS:** En tamaños más grandes,  
las tuercas pueden suministrarse con  
tuerca con seguro

# Hilo NPTF Macho Interlock (AGN)

26.0400.

SAE J516 / SAE J476A

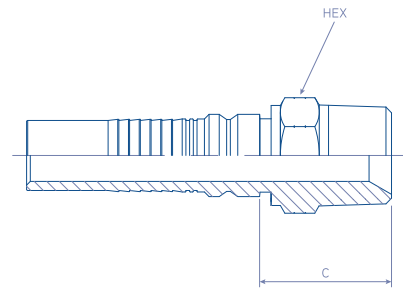

REFERENCIA	manguera tabla medidas	manguera Ø pulg.	hilo pulg.	C Corte mm	HEX mm
26.0400.1212	-12	3/4"	3/4" - 14	36.0	27
26.0400.1616	-16	1"	1" - 11.1/2	46.0	36
26.0400.2020	-20	1.1/4"	1.1/4" - 11.1/2	50.7	46
26.0400.2424	-24	1.1/2"	1.1/2" - 11.1/2	50.5	50
26.0400.3232	-32	2"	2" - 11.1/2	57.5	65

**MATERIAL:** Acero al carbono

**ACABADO:** Enchapado sin cromo-(VI) / conforme a ROHS

**VERSIONES:** Acero inoxidable (agregue una 'S' al final de la REFERENCIA)

# Hembra giratoria Interlock ORFS

26.4414.

ISO 12151-1 / ISO 8434-3 / SAE J516

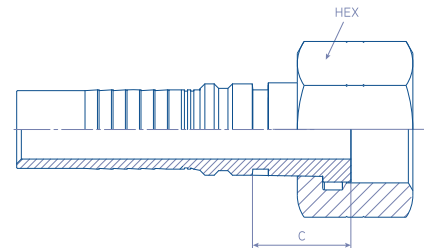

REFERENCIA	manguera tabla medidas	manguera Ø pulg.	hilo pulg.	C Corte mm	HEX mm
26.4414.1212	-12	3/4"	1.3/16" - 14	29.0	36
26.4414.1616	-16	1"	1.7/16" - 12	31.6	41
26.4414.2020	-20	1.1/4"	1.11/16" - 12	31.5	50
26.4414.2424	-24	1.1/2"	2" - 12	33.7	50

**MATERIAL:** Acero al carbono

**ACABADO:** Enchapado sin cromo-(VI) / conforme a ROHS

**VERSIONES:** Acero inoxidable (agregue una 'S' al final de la REFERENCIA)



# Hembra Giratoria Interlock ORFS, Codo 45°

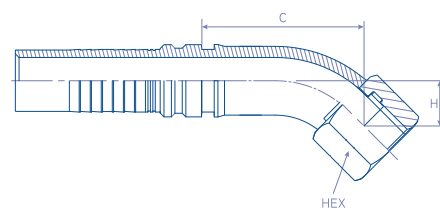

26.4444.

ISO 12151-5 / ISO 8434-2 / SAE J516 / SAE J514

REFERENCIA	manguera tabla medidas	manguera Ø pulg.	hilo pulg.	C Corte mm	H mm	HEX mm
26.4444.1212	-12	3/4"	1.3/16" - 14	60.0	23.1	36
26.4444.1616	-16	1"	1.7/16" - 12	76.0	28.5	41
26.4444.2020	-20	1.1/4"	1.11/16" - 12	95.0	37.0	50
26.4444.2424	-24	1.1/2"	2" - 12	120.0	46.0	60

**MATERIAL:** Acero al carbono

**ACABADO:** Enchapado sin cromo-(VI) / conforme a ROHS

**VERSIONES:** Acero inoxidable (agregue una 'S' al final de la REFERENCIA)

# Hembra Giratoria Interlock ORFS, Codo 90°

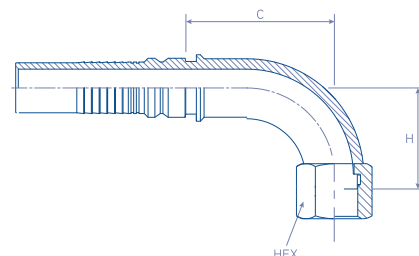

26.4494.

ISO 12151-5 / ISO 8434-2 / SAE J516 / SAE J514

REFERENCIA	manguera tabla medidas	manguera Ø pulg.	hilo pulg.	C Corte mm	H mm	HEX mm
26.4494.1212	-12	3/4"	1.3/16" - 14	56.0	52.0	36
26.4494.1616	-16	1"	1.7/16" - 12	72.0	62.5	41
26.4494.2020	-20	1.1/4"	1.11/16" - 12	86.0	77.0	50
26.4494.2424	-24	1.1/2"	2" - 12	98.0	94.0	60

**MATERIAL:** Acero al carbono

**ACABADO:** Enchapado sin cromo-(VI) / conforme a ROHS

**VERSIONES:** Acero inoxidable (agregue una 'S' al final de la REFERENCIA)

# Flange SAE Recta Interlock (código 61) 3000 PSI (SFL)

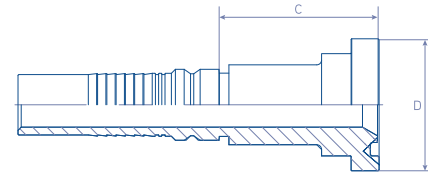

26.7013.

ISO 6162-1 / ISO 12151-3 / SAE J516 / SAE J518

REFERENCIA	manguera	manguera Ø	D Ø Flange	C Corte
	tabla medidas	pulg.	mm	mm
26.7013.1212	-12	3/4"	38.1	40.0
26.7013.1216	-12	3/4"	44.5	43.0
26.7013.1616	-16	1"	44.5	44.5
26.7013.1620	-16	1"	50.8	44.5
26.7013.2020	-20	1.1/4"	50.8	46.7
26.7013.2024	-20	1.1/4"	60.3	49.0
26.7013.2424	-24	1.1/2"	60.3	50.5
26.7013.2432	-24	1.1/2"	71.4	72.0
26.7013.3232	-32	2"	71.4	73.5

**MATERIAL:** Acero al carbono

**ACABADO:** Enchapado sin cromo-(VI) / conforme a ROHS

**VERSIONES:** Acero inoxidable (agregue una 'S' al final de la REFERENCIA)

# Flange SAE Recta Interlock (código 61) 3000 PSI, Codo 45° (SFL 45°)

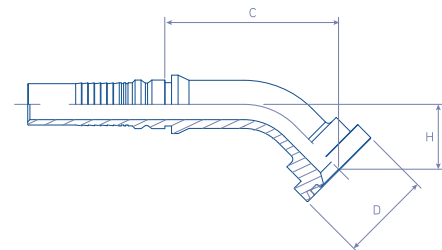

26.7043.

ISO 6162-1 / ISO 12151-3 / SAE J516 / SAE J518

REFERENCIA	manguera	manguera Ø	D Ø Flange	C Corte	H
	tabla medidas	pulg.	mm	mm	mm
26.7043.1212	-12	3/4"	38.1	68.5	26.7
26.7043.1216	-12	3/4"	44.5	68.0	30.6
26.7043.1616	-16	1"	44.5	82.5	32.5
26.7043.1620	-16	1"	50.8	83.0	34.5
26.7043.2020	-20	1.1/4"	50.8	84.3	31.0
26.7043.2024	-20	1.1/4"	60.3	87.1	31.0
26.7043.2424	-24	1.1/2"	60.3	123.0	46.5
26.7043.2432	-24	1.1/2"	71.4	123.5	50.5
26.7043.3232	-32	2"	71.4	140.0	53.2

**MATERIAL:** Acero al carbono

**ACABADO:** Enchapado sin cromo-(VI) / conforme a ROHS

**VERSIONES:** Acero inoxidable (agregue una 'S' al final de la REFERENCIA)



# Flange SAE Recta Interlock (código 61) 3000 PSI, Codo 90° (SFL 90°)

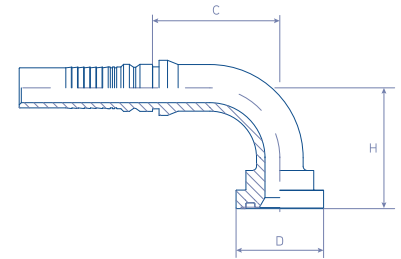

26.7093.

ISO 6162-1 / ISO 12151-3 / SAE J516 / SAE J518

REFERENCIA	manguera tabla medidas	manguera Ø pulg.	D Ø Flange mm	C Corte mm	H mm
26.7093.1212	-12	3/4"	38.1	63.0	56.5
26.7093.1216	-12	3/4"	44.5	58.0	58.0
26.7093.1616	-16	1"	44.5	75.0	65.0
26.7093.1620	-16	1"	50.8	67.5	61.0
26.7093.2020	-20	1.1/4"	50.8	83.7	69.2
26.7093.2024	-20	1.1/4"	60.3	82.3	69.2
26.7093.2424	-24	1.1/2"	60.3	109.0	90.0
26.7093.2432	-24	1.1/2"	71.4	109.0	104.0
26.7093.3232	-32	2"	71.4	145.0	123.0

**MATERIAL:** Acero al carbono

**ACABADO:** Enchapado sin cromo-(VI) / conforme a ROHS

**VERSIONES:** Acero inoxidable (agregue una 'S' al final de la REFERENCIA)

# Flange SAE Recta Interlock (código 62) 6000 PSI (SFS)

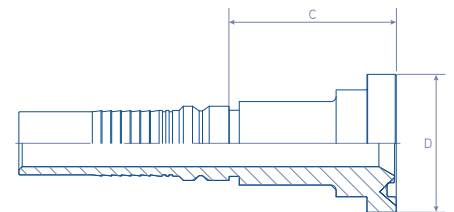

26.7016.

ISO 6162-1 / ISO 12151-3 / SAE J516 / SAE J518

REFERENCIA	manguera tabla medidas	manguera Ø pulg.	D Ø Flange mm	C Corte mm
26.7016.1212	-12	3/4"	41.3	46.0
26.7016.1216	-12	3/4"	47.6	56.5
26.7016.1616	-16	1"	47.6	57.5
26.7016.1620	-16	1"	54.0	64.5
26.7016.2020	-20	1.1/4"	54.0	67.2
26.7016.2024	-20	1.1/4"	63.5	71.0
26.7016.2424	-24	1.1/2"	63.5	73.0
26.7016.2432	-24	1.1/2"	79.4	75.0
26.7016.3232	-32	2"	79.4	83.5

**MATERIAL:** Acero al carbono

**ACABADO:** Enchapado sin cromo-(VI) / conforme a ROHS

**VERSIONES:** Acero inoxidable (agregue una 'S' al final de la REFERENCIA)

# Flange SAE Recta Interlock (código 62) 6000 PSI, Codo 45° (SFS 45°)

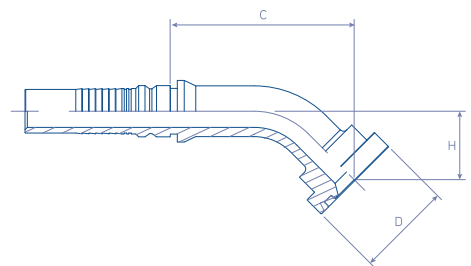

26.7046.

ISO 6162-1 / ISO 12151-3 / SAE J516 / SAE J518

REFERENCIA	manguera tabla medidas	manguera Ø pulg.	D Ø Flange mm	C Corte mm	H mm
26.7046.1212	-12	3/4"	41.3	69.0	29.5
26.7046.1216	-12	3/4"	47.6	77.0	33.0
26.7046.1616	-16	1"	47.6	79.0	31.0
26.7046.1620	-16	1"	54.0	99.0	39.0
26.7046.2020	-20	1.1/4"	54.0	110.0	44.0
26.7046.2024	-20	1.1/4"	63.5	112.7	48.0
26.7046.2424	-24	1.1/2"	63.5	115.0	47.0
26.7046.2432	-24	1.1/2"	79.4	131.3	57.0
26.7046.3232	-32	2"	79.4	154.0	64.0

**MATERIAL:** Acero al carbono

**ACABADO:** Enchapado sin cromo-(VI) / conforme a ROHS

**VERSIONES:** Acero inoxidable (agregue una 'S' al final de la REFERENCIA)

# Flange SAE Interlock (código 62) 6000 PSI, Codo 90° (SFS 90°)

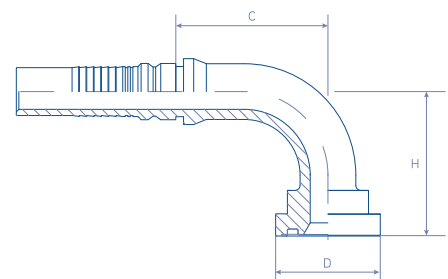

26.7096.

ISO 6162-1 / ISO 12151-3 / SAE J516 / SAE J518

REFERENCIA	manguera tabla medidas	manguera Ø pulg.	D Ø Flange mm	C Corte mm	H mm
26.7096.1212	-12	3/4"	41.3	55.0	58.0
26.7096.1216	-12	3/4"	47.6	58.0	65.0
26.7096.1616	-16	1"	47.6	77.0	66.0
26.7096.1620	-16	1"	54.0	76.0	80.0
26.7096.2020	-20	1.1/4"	54.0	97.2	86.0
26.7096.2024	-20	1.1/4"	63.5	99.9	100.0
26.7096.2424	-24	1.1/2"	63.5	108.5	104.0
26.7096.2432	-24	1.1/2"	79.4	107.5	119.5
26.7096.3232	-32	2"	79.4	145.0	134.0

**MATERIAL:** Acero al carbono

**ACABADO:** Enchapado sin cromo-(VI) / conforme a ROHS

**VERSIONES:** Acero inoxidable (agregue una 'S' al final de la REFERENCIA)



# Flange Recta Interlock SUPERCAT

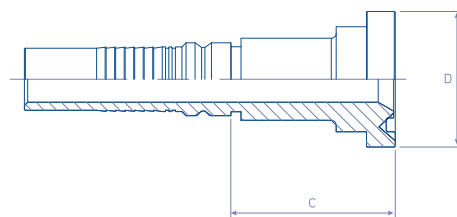

26.7116.

ISO 6162-2 / ISO 12151-3 / SAE J516 / SAE J518

REFERENCIA	manguera	manguera Ø	D Ø Flange	C Corte
	tabla medidas	pulg.	mm	mm
26.7116.1212	-12	3/4"	41.3	50.0
26.7116.1216	-12	3/4"	47.6	64.0
26.7116.1616	-16	1"	47.6	65.0
26.7116.1620	-16	1"	54.0	71.0
26.7116.2020	-20	1.1/4"	54.0	73.0
26.7116.2024	-20	1.1/4"	63.5	84.0
26.7116.2424	-24	1.1/2"	63.5	77.0
26.7116.2432	-24	1.1/2"	79.4	82.0
26.7116.3232	-32	2"	79.4	90.0

**MATERIAL:** Acero al carbono

**ACABADO:** Enchapado sin cromo-(VI) / conforme a ROHS

**VERSIONES:** Acero inoxidable (agregue una 'S' al final de la REFERENCIA)

# Flange Interlock SUPERCAT, Codo 45°

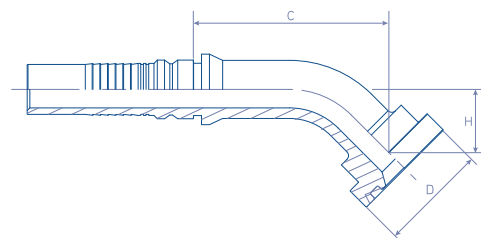

26.7146.

ISO 6162-2 / ISO 12151-3 / SAE J516 / SAE J518

REFERENCIA	manguera	manguera Ø	D Ø Flange	C Corte	H
	tabla medidas	pulg.	mm	mm	mm
26.7146.1212	-12	3/4"	41.3	72.0	32.0
26.7146.1216	-12	3/4"	47.6	79.0	36.0
26.7146.1616	-16	1"	47.6	83.0	34.0
26.7146.1620	-16	1"	54.0	95.0	41.0
26.7146.2020	-20	1.1/4"	54.0	114.0	46.0
26.7146.2024	-20	1.1/4"	63.5	116.0	48.0
26.7146.2424	-24	1.1/2"	63.5	120.0	48.0
26.7146.2432	-24	1.1/2"	79.4	132.0	59.0
26.7146.3232	-32	2"	79.4	170.0	63.0

**MATERIAL:** Acero al carbono

**ACABADO:** Enchapado sin cromo-(VI) / conforme a ROHS

**VERSIONES:** Acero inoxidable (agregue una 'S' al final de la REFERENCIA)

# Flange Interlock SUPERCAT, Codo 90°

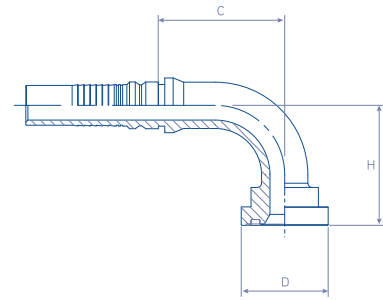

26.7196.

ISO 6162-2 / ISO 12151-3 / SAE J516 / SAE J518

REFERENCIA	manguera tabla medidas	manguera Ø pulg.	D Ø Flange mm	C Corte mm	H mm
26.7196.1212	-12	3/4"	41.3	57.0	60.0
26.7196.1216	-12	3/4"	47.6	57.0	68.0
26.7196.1616	-16	1"	47.6	78.0	70.0
26.7196.1620	-16	1"	54.0	78.0	82.0
26.7196.2020	-20	1.1/4"	54.0	106.0	90.0
26.7196.2024	-20	1.1/4"	63.5	106.0	100.0
26.7196.2424	-24	1.1/2"	63.5	113.0	106.0
26.7196.2432	-24	1.1/2"	79.4	113.0	122.0
26.7196.3232	-32	2"	79.4	153.0	134.0

**MATERIAL:** Acero al carbono

**ACABADO:** Enchapado sin cromo-(VI) / conforme a ROHS

**VERSIONES:** Acero inoxidable (agregue una 'S' al final de la REFERENCIA)

# Macho Métrico Interlock, Serie Pesada Asiento Cono 24° (CES)

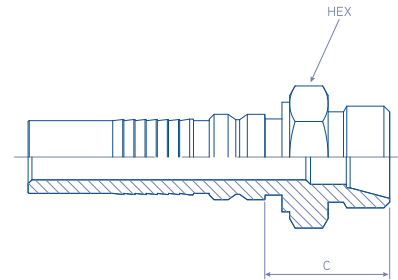

26.1100.

ISO 12151-2 / ISO 8434-1

REFERENCIA	manguera tabla medidas	manguera Ø pulg.	hilo	d Tubo mm	C Corte mm	HEX mm
26.1100.1236	-12	3/4"	M36 x 2.0	25	44.0	41
26.1100.1642	-16	1"	M42 x 2.0	30	42.0	46
26.1100.2052	-20	1.1/4"	M52 x 2.0	38	48.2	55

**MATERIAL:** Acero al carbono

**ACABADO:** Enchapado sin cromo-(VI) / conforme a ROHS

**VERSIONES:** Acero inoxidable (agregue una 'S' al final de la REFERENCIA)



# Hembra Métrica Giratoria Interlock, Serie Pesada Asiento Cono 24° (DKOS)

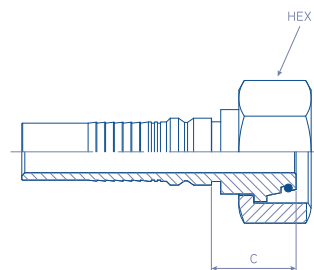

26.5113.

ISO 12151-2 / ISO 8434-1

REFERENCIA	manguera tabla medidas	manguera Ø pulg.	hilo	d Tubo mm	C Corte mm	HEX mm
26.5113.1236	-12	3/4"	M36 x 2.0	25	32.0	46
26.5113.1642	-16	1"	M42 x 2.0	30	35.5	50
26.5113.2052	-20	1,1/4"	M52 x 2.0	30	38.7	60

**MATERIAL:** Acero al carbono

**ACABADO:** Enchapado sin cromo-(VI) / conforme a ROHS

**VERSIONES:** Acero inoxidable (agregue una 'S' al final de la REFERENCIA)

# Hembra Métrica Giratoria Interlock, Serie Pesada Asiento Cono 24°, Codo 45° (DKOS 45)

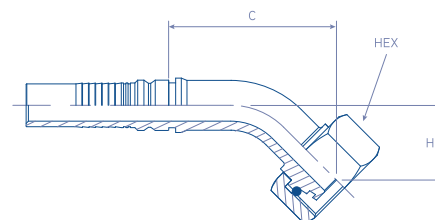

26.5143.

ISO 12151-2 / ISO 8434-1

REFERENCIA	manguera tabla medidas	manguera Ø pulg.	hilo	d Tubo mm	C Corte mm	H mm	HEX mm
26.5143.1236	-12	3/4"	M36 x 2.0	25	88.0	31.0	46
26.5143.1642	-16	1"	M42 x 2.0	30	93.3	39.0	50
26.5143.2052	-20	1,1/4"	M52 x 2.0	38	115.1	46.5	60

**MATERIAL:** Acero al carbono

**ACABADO:** Enchapado sin cromo-(VI) / conforme a ROHS

**VERSIONES:** Acero inoxidable (agregue una 'S' al final de la REFERENCIA)

# Hembra Métrica Giratoria Interlock, Serie Pesada Asiento Cono 24°, Codo 90 (DKOS 90)

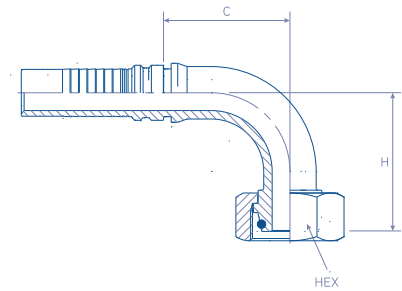

26.5193.

ISO 12151-2 / ISO 8434-1

REFERENCIA	manguera tabla medidas	manguera Ø pulg.	hilo	d Tubo mm	C Corte mm	H mm	HEX mm
26.5193.1236	-12	3/4"	M36 x 2.0	25	56.0	60.0	46
26.5193.1642	-16	1"	M42 x 2.0	30	76.0	75.0	50
26.5193.2052	-20	1.1/4"	M52 x 2.0	38	92.0	96.0	60

**MATERIAL:** Acero al carbono

**ACABADO:** Enchapado sin cromo-(VI) / conforme a ROHS

**VERSIONES:** Acero inoxidable (agregue una 'S' al final de la REFERENCIA)



## **GARANTÍA LIMITADA DE PRODUCTOS**

Balflex® garantiza a nuestros clientes que los productos que vende no presentarán defectos de materiales ni de mano de obra cuando se despachen en las bodegas de Balflex®.

Todas las solicitudes de garantía deberán presentarse por escrito a Balflex®. La responsabilidad de Balflex® conforme a este documento se limita al precio de compra de la mercancía que se compruebe sea defectuosa o, bajo exclusivo criterio de Balflex, a reemplazar tal mercancía tras su devolución autorizada a Balflex®.

Esta garantía reemplaza y excluye a todas las demás garantías, o condiciones manifestadas, implícitas, estatutarias o de algún otro modo creadas bajo la legislación vigente, incluyendo (pero sin limitarse a ello) a la garantía de comerciabilidad y garantía de idoneidad para un fin particular.

Asimismo, esta garantía no regirá ni tendrá validez para ningún producto o parte del mismo que se haya sometido a abuso, uso incorrecto, instalación, mantenimiento o funcionamiento inadecuados, fallas eléctricas o condiciones anormales, así como a productos que se hayan intervenido, alterado, modificado, reparado o reacondicionado por cualquier persona no autorizada por Balflex o que se haya utilizado de cualquier otro modo inconsistentemente con cualquier instrucción o especificación de Balflex®. Balflex® rechaza todas las responsabilidades por cualquier conjunto de manguera que no se haya producido en conformidad con las piezas y recomendaciones de montaje de Balflex®.

Bajo ninguna circunstancia Balflex se responsabilizará en absoluto con ninguna persona, incluyendo, entre otros, cualquier comprador inmediato, adquirente u otra tercera parte, por cualquier daño especial, punitivo, fortuito o resultante, incluyendo (pero sin limitarse a ello) la pérdida de utilidades o pérdida de clientes, pérdidas o daños a la propiedad física del cliente o de cualquier otra persona, y pérdida anticipada de ingresos, utilidades, reputación comercial, ahorros u otro tipo de pérdida económica del cliente o de cualquier otra persona.

Las especificaciones están sujetas a cambios sin previo aviso.  
Se excluyen los errores y omisiones.



## EE. UU. y Canadá

6000 South Loop East Freeway

Houston, Tx 77033

Estados Unidos de América

Tél: (1) 713-928-6064

Correo electrónico: [sales@balflex.com](mailto:sales@balflex.com)

[www.balflexusa.com](http://www.balflexusa.com)

## Oficina Central en Europa

R. Bouça dos Estilhadouros, 226/254

4445-044 Alfena, Portugal

Tél: (351) 229 698 160

Correo electrónico: [balflex@balflex.com](mailto:balflex@balflex.com)

[www.balflex.com](http://www.balflex.com)

## Alemania

Franckensteinstraße 8

77749 Hohberg

Tel: (49) 07808 4318857

Correo electrónico: [info@2bhydraulik.de](mailto:info@2bhydraulik.de)

[www.balflex.com](http://www.balflex.com)

## América del Sur

R. Padre Cesari Lelli, 1014

Rodovia BR-116

CEP 83420-000 Quatro Barras/PR

Brasil

Tél: (55) 41 3671 3450

Correo electrónico: [comercial@balflex.com.br](mailto:comercial@balflex.com.br)

[www.balflex.com](http://www.balflex.com)

Una Compañía ISO 9001:2015:



Cofinanciado por:



UNIÃO EUROPEIA  
Fundo Europeu  
de Desenvolvimento Regional

